



# STATEMENT OF PROJECT 25 (P25) USER NEEDS

---

AUGUST 2020

# Table of Contents

<b>Forward</b> .....	<b>iv</b>
<b>Introduction</b> .....	<b>1</b>
History and Purpose .....	1
Purpose .....	2
Scope .....	2
Project 25 Background .....	3
The P25 System Model – How the P25 Standards are Organized to Support Standards-Based Interoperability ...	3
P25 System Components – How Users Interact with P25.....	5
<b>Section 1 – P25 Features, Functions and Services</b> .....	<b>6</b>
Voice Services.....	7
Data Services .....	8
Control Data Packets and Supplementary Data Services.....	8
Security Services .....	9
Encryption and Encrypted Calls .....	9
Key Management.....	10
Location Services.....	11
Subscriber Management Functions.....	11
Upcoming Features and Functions .....	11
<b>Section 2 – P25 Infrastructure and Interfaces</b> .....	<b>12</b>
General P25 System Types .....	13
Conventional and Trunking Modes.....	13
Conventional .....	13
Trunking .....	14
Simplex, Half-Duplex, and Full-Duplex Operations .....	16
Wide Area Networks .....	16
Coverage Configurations.....	17
P25 Network Control Elements .....	18
P25 Interfaces and Services.....	20
P25 Common Air Interface (CAI) – Um Interface .....	21

P25 Fixed Station Subsystem Interface (FSSI or FSI) – Ef Interface .....	22
Inter-RF Subsystem Interface (ISSI) – G Interface .....	23
Key Management Interfaces .....	23
Non-P25 Interfaces .....	24
Telephone Interconnect Interface – Et Interface.....	24
Network Management Interface – En Interface .....	25
Packet Data Host Network Interface.....	25
<b>Section 3 – P25 Consoles .....</b>	<b>26</b>
Console Description .....	27
Console Interfaces .....	27
Console Subsystem Interface (CSSI) – Ec Interface .....	28
Fixed Station Interface (FSI) – Ef Interface.....	28
Inter-RF Subsystem Interface (ISSI) – G interface .....	28
Non-Standard Interfaces .....	29
<b>Section 4 – Subscriber Equipment .....</b>	<b>30</b>
P25 Subscriber Units .....	31
Subscriber Unit Interfaces .....	31
Common Air Interface.....	31
Mobile Data Peripheral Interface.....	31
Digital Vehicular Repeater Systems.....	32
P25 Compliance Assessment Program Testing.....	32
<b>Appendix A – List of User Needs for P25 Features, Functions, and Services .....</b>	<b>A-1</b>
<b>Appendix B – List of User Needs for P25 Infrastructure .....</b>	<b>B-1</b>
<b>Appendix C – List of User Needs for P25 Consoles .....</b>	<b>C-1</b>
<b>Appendix D – List of User Needs for P25 Subscriber Equipment .....</b>	<b>D-1</b>
<b>Appendix E – Features and Functions Applicable to Each Interface .....</b>	<b>E-1</b>
<b>Appendix F – Additional Resources.....</b>	<b>F-1</b>
<b>Appendix G – Acronyms .....</b>	<b>G-1</b>

# List Of Figures

- Figure 1 – P25 System Model .....4
- Figure 2 – P25 Security Services Key Management Overview.....10
- Figure 3 – FDMA Conventional.....13
- Figure 4 – FDMA Trunking.....14
- Figure 5 – TDMA Trunking.....15
- Figure 6 – Phase 1 and Phase 2 Comparison.....15
- Figure 7 – Wide Area P25 Network with IP Backhaul .....16
- Figure 9 – Multicast Layout.....17
- Figure 8 – Simulcast Layout .....17
- Figure 10 – Simulcast Voting Example .....18
- Figure 11 – Example of logical channel assignment for conventional and trunking systems with three RF channels (repeaters).....19
- Figure 12 – P25 Interfaces and Services.....20
- Figure 13 – Common Air Interface.....22
- Figure 14 – Inter-RF Subsystem Interface .....23
- Figure 15 – Telephone Interconnect Interface.....24
- Figure 16 – Data Network Interface.....25
- Figure 17 – Console Subsystem Connected to Base Station .....27
- Figure 18 – Console Subsystem Interface .....28
- Figure 19 – Fixed Station Interface .....28
- Figure 20 – Subscriber Unit Overview .....31

# List of Tables

- Table 1 – P25 Interfaces Overview.....21
- Table 2 – Non-P25 Interfaces Commonly Used with P25 Systems.....24

# Forward

The Statement of Project 25 (P25) User Needs (SPUN) provides land mobile radio (LMR) users with an overview of P25 Standards and a framework for identifying and defining their communications needs. It was developed by the Project 25 Steering Committee with support from the Cybersecurity and Infrastructure Security Agency (CISA).

The Steering Committee is composed of representatives from the Association of Public Safety Communications Officials, International (APCO), the National Association of State Technology Directors (NASTD), and federal and other public safety user agencies. The committee provides user input that guides the P25 Standards development process and holds final approval authority over all P25 Standards.

CISA partners with industry and government to understand and manage risk to our Nation's critical infrastructure. The agency conducts extensive nationwide programs in support of the ability of emergency responders and other government officials to communicate effectively during interjurisdictional incidents. In that capacity, CISA provides technical and administrative support to the Steering Committee.

Essential to the development of this document was the participation of the Telecommunications Industry Association's P25 Engineering Committee (TIA TR-8), which formulates and maintains standards for private radio communications systems and equipment. TR-8 addresses technical matters ranging from definitions and interoperability specifications to compatibility and compliance requirements. Much of the committee's work relates to the formulation of TIA-102 Series standards for Project 25.

---

## STATEMENT OF P25 USER NEEDS

---

# Introduction

## History and Purpose

The Statement of Project 25 (P25) User Needs (SPUN) is derived from the original P25 Statement of Requirements (SoR) document,<sup>1</sup> and describes user needs and P25 functionality from the perspective of P25 users. This document provides high-level explanations of P25 system architecture, features, and functions as defined in the Telecommunications Industry Association (TIA) 102 Suite of Standards (P25 Standards) and as communicated by P25 public safety users and system administrators.

---

<sup>1</sup> The [P25 Statement of Requirements \(SoR\)](#), the P25 Technology Interest Group Capabilities Guide, the P25 Standards, and other P25 related documents served as reference materials for this document. Other reference documents can be found in **Appendix F – Additional Resources**.

# Purpose

Any discussion of the P25 Standards and the needs of those who rely on them must start with the purpose of P25 and how P25 system architecture, interfaces, and services fulfill that purpose. At its most basic, P25 is a set of standards that manufacturers can follow to ensure that their land mobile radio (LMR) equipment can interoperate (communicate) with equipment produced by other manufacturers. As a result, emergency responders and others who rely on LMR equipment and systems for critical communications can be assured that equipment from various manufacturers can be configured to work together.

While the concept of interoperable communications<sup>2</sup> sounds simple, the technical challenges can be daunting, and developing standards that meet those challenges has been an ongoing effort among practitioners, engineers, and manufacturers for more than 30 years. P25 development has always been a user-driven process. User needs were at the core of the original P25 Statement of Requirements (SoR) document and continue to guide the process as public safety communications evolves to include data as well as voice functionality. The P25 Steering Committee relies on practitioners to identify, prioritize, and communicate their needs.

# Scope

This document offers a description of the P25 system model and the organization of P25 Standards documents to give users a baseline of current P25 capabilities and features. The SPUN also provides a framework for users to review, identify, and effectively communicate their needs to those involved in the standards-development process: the Association of Public Safety Communications Officials (APCO) Project 25 Interface Committee (APIC) and the TIA TR-8 Engineering Committee and the P25 Steering Committee (SC) (**Sections 1-4**).

APIC, P25 SC, and the TIA TR-8 Engineering Committee have used the original P25 SoR to develop American National Standards Institute (ANSI)/TIA standards, TIA Telecommunications Systems Bulletins, and other P25 documentation that together comprise what are broadly referred to as the P25 List of Approved Standards (P25 Standards). The SPUN is a companion/succession document to the SoR, designed to reflect the current, relatively mature state of P25. It includes lists of high-level user needs (**Appendices A-D**) useful for guiding the efforts of APIC and TIA and encouraging discussion and participation from the public safety community. The appendices present these needs in a condensed format, and readers should understand that most are derived from the SoR or have been met by the current P25 Standards.

That said, not all services, features, and capabilities listed in the user needs tables are addressed by current P25 Standards and/or available on the market. In practice, most P25 systems do not include all the services, features, and capabilities described in this document. **This document is intended as a resource for understanding P25 Standards and user needs related to those standards. The lists of user needs should not be considered a complete or binding list of P25 requirements for procurement decisions.** Finally, as technologies advance, new user needs likely will emerge and existing needs will be modified or removed.

---

2 For more information on achieving interoperable communications, the [SAFECOM Interoperability Continuum](#) provides a framework for emergency response agencies at the federal, state, local, and tribal levels to use for planning and implementation of interoperability solutions.

# Project 25 Background

P25 is a multi-phase, multi-year project to establish a standards profile for the operations and functionality of digital narrowband private LMR systems that meet the operational needs of the public safety communications community. This project has the goal of:

- Maximizing radio frequency spectrum use
- Ensuring competition among manufacturers throughout the equipment lifecycle, from initial procurement through replacement
- Enabling effective, efficient, and reliable intra-agency and inter-agency communications
- Providing “user friendly” equipment that reduces the amount of mental and physical interaction by the operator, and
- Providing a path for migration from analog technology to digital P25.

Collaboration among organizations already mentioned and the public safety community has led to more than 90 documents that define P25 interfaces, services, features, and “standards-based interoperability” within the P25 system model. The result is a solid foundation for “public safety grade”<sup>3</sup> systems and equipment identified by and built for the public safety community.

## The P25 System Model – How the P25 Standards are Organized to Support Standards-Based Interoperability

The general concept of a “P25 system,” both conventional and trunked, relies on open system interfaces and standardized features, functions, and services that enable interoperation among compatible hardware and software products from P25 suppliers. **Figure 1** represents a “general system model” that includes components and interfaces often found within a P25 system.

At its core, the P25 Standards suite focuses on interfaces and standardized sets of formats, messages, protocols, and procedures that ensure voice and data messages are sent and received in a standardized manner. This interface-focused approach identifies select reference points (i.e., interfaces) at which disparate manufacturers’ systems and user equipment can exchange information. To date, P25 has defined eight such interfaces, with the common air interface (CAI) as the most important and widely adopted interface. In addition to interfaces, P25 also defines multiple services and features and their applicability to each interface<sup>4</sup>.

In **Figure 1**, each Radio Frequency Sub-System (RF Subsystem or RFSS) represents an infrastructure component comprised of any collection of site equipment across one or multiple RF sites. Each RFSS can be considered a “black box” supporting the CAI and all necessary logic control for establishing, processing, and terminating calls. Modern P25 systems also provide limited data functions using CAI and standard IP data formats. The RFSS is bounded by standardized and open interfaces that enable control messages and protocols to pass voice and data

3 “[Is Project 25 Public Safety Grade?](#)” (March 2016) provides more information on this topic.

4 Project 25 Technology Interest Group (PTIG) Whitepaper on P25 Compliance, <http://www.project25.org/index.php/documents/p25-whitepapers#>



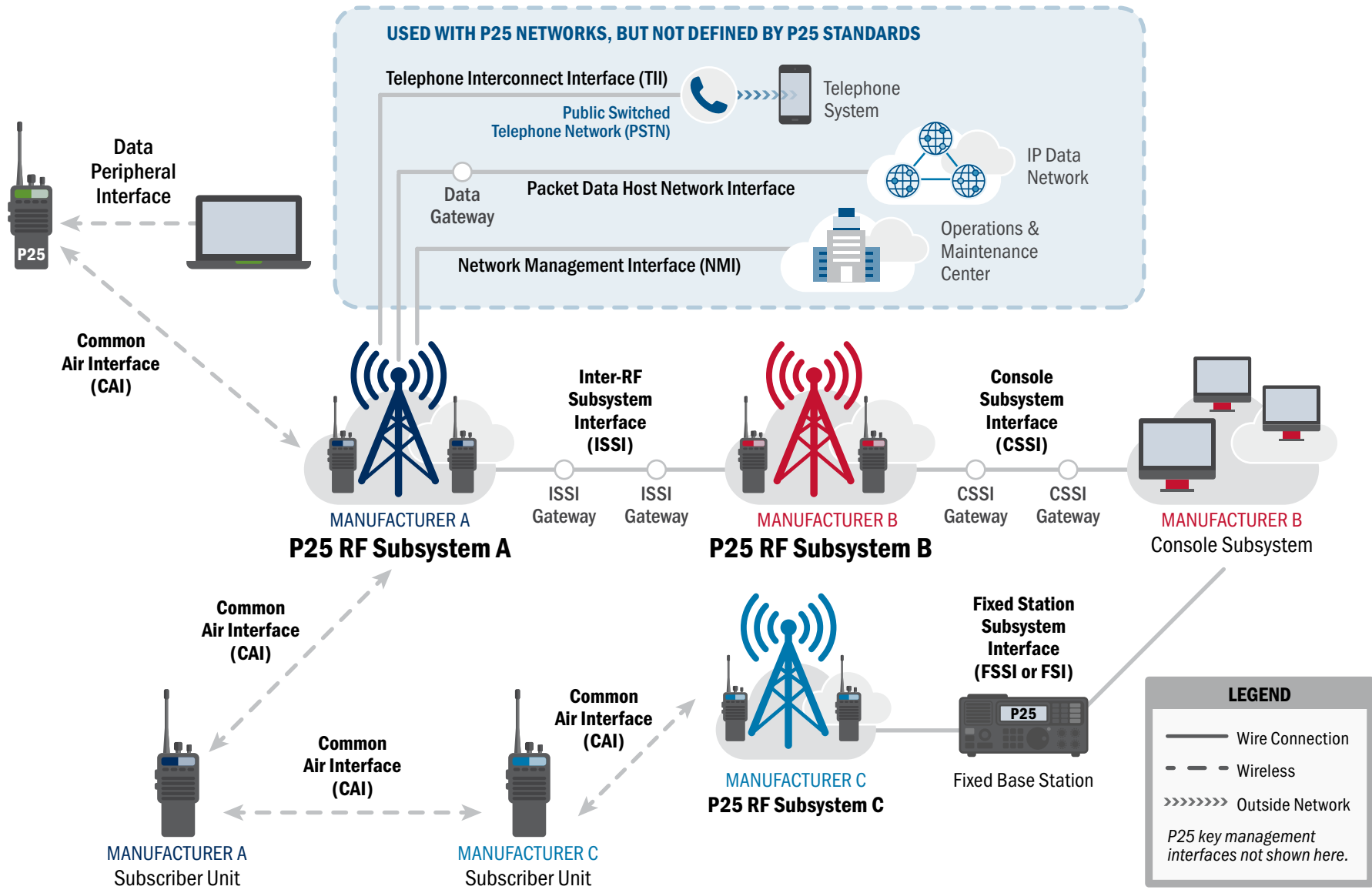

Figure 1 – P25 System Model

traffic to other RFSS(s), console subsystems, and connected networks. P25 Standards do not dictate design and configuration options within each RFSS; manufacturers have ample opportunities to innovate and differentiate their product offerings within their specific subsystems.

RFSSs serve as modular building blocks for wide area networks. This approach provides end users the flexibility to use different system architectures and configurations, subscriber units (SU), and consoles while still maintaining P25 compliance.

## P25 System Components – How Users Interact with P25

P25 end users rely on P25 consoles and subscriber equipment to communicate over available and appropriate RF resources (i.e., talkpaths). Thus end users are more concerned with subscriber and console features and functions than system infrastructure. System administrators and operators, on the other hand, must more fully understand system infrastructure and configuration options in order to effectively manage a P25 system.

This document serves as a bridge between technical specifications found in the TIA P25 standards and higher-level user needs. Because not all users must fully understand every aspect of P25 interfaces and system design as defined in the SoR and TIA documentation, this document is organized into the following sections to allow all readers to easily find topics most relevant to their line of work:

- **Section 1 – P25 Features, Functions and Services**  
This section reviews common features, functions, and services found in P25 systems that are expected to work across a wide range of system designs and configurations using standardized P25 interfaces, message formats, and procedures, where applicable. These features, functions, and services provide radio users, console operators, and system operators or administrators with critical communications capabilities.
- **Section 2 – P25 Infrastructure and Interfaces**  
This section addresses system infrastructure, configurations, and P25 interfaces that enable interoperability between subsystems forming a wide area network. Variations in P25 infrastructure and interface offerings provide decision makers, engineers, and system operators and administrators with options for designing interoperable P25 systems that fit their unique requirements. While there is no “one size fits all” solution, this section includes explanations of common system types that impact RF resource allocation, coverage, capability, and resiliency.
- **Section 3 – P25 Consoles**  
This section examines console equipment, interfaces, standards, and tools that link the console subsystem to P25 system infrastructure and enable voice and data capabilities at the emergency communications center (ECC), public safety answering point (PSAP) and/or dispatch position.
- **Section 4 – Subscriber Equipment**  
This section addresses P25 subscriber units –portable and mobile radios—that allow end users to communicate with other users and console operators with or without the presence of P25 network infrastructure.

The major sections of this document provide overviews on each of these topics.

**For those familiar with P25 systems and interfaces and are solely interested in P25 user needs, Appendices A through D provide a detailed listing of P25 user needs corresponding to each section.**

---

## SECTION 1

---

# P25 Features, Functions, and Services

The P25 standards cover voice and/or data services that can be adapted to all public safety radio frequency bands and are expected to work across a wide range of system designs and configurations. These services are primarily enabled by the CAI between subscriber equipment and the network infrastructure. However, in wide area networks, other interfaces – predominantly the Inter-RF Subsystem Interface (ISSI) and the Console Subsystem Interface (CSSI) – play important roles in the operability of these features, functions, and services across multiple RFSSs.

To “standardize” a feature, the P25 standards body (TIA TR-8) must define and approve a set of messaging procedures, protocols and technical specifications for the new feature and amend other impacted functions or services to ensure continued operability of all P25 features. TIA TR-8 also develops testing specifications and recommendations<sup>5</sup> designed to verify manufacturer implementations of each feature or service. For example, services such as Over-the-Air-Rekeying (OTAR), link layer encryption (LLE), and P25 location services required the creation and revision of multiple standards documents. This level of documentation enables standards-based interoperability of features regardless of manufacturer, assuming those features are implemented according to the standard. This process generally ensures the capabilities of each P25 interface and service increases with each new release of the applicable standard. As technology and user needs evolve, TIA TR-8 continues to maintain and update the entire P25 Standards suite.

**P25 is a voluntary standard that provides a well-defined path to standards-based interoperability. This means that P25 does not mandate or guarantee the inclusion of all standardized features, functions, and services in every system.** What is incorporated into a system is left to the discretion of the manufacturers and the public safety community. Manufacturers typically include a subset of P25-standardized features, functions, and services as a baseline<sup>6</sup> for system functionality and offer others as options. **Similarly, P25 does not preclude the inclusion of services or features not explicitly defined within the P25 Standards** but does offer some provisions for the implementation of proprietary features.

Because P25 is built upon flexibility and customization, there is no one-size-fits-all P25 system. Features, functions and services available on a trunked system differ from those available on a conventional system (explained in more detail in **Section 2 – Infrastructure**). Factors such as system configuration, air interface type (Frequency-division multiple access [FDMA] versus Time-division multiple access [TDMA]), manufacturer implementations, and interoperability also can impact availability and operability of P25 features, functions and services. So it is important to know what features are available for a given system configuration and if they are implemented according to P25 Standards.

Below are categories and examples of features, functions, and services common to P25 systems. **They are explained in more detail in Appendix A.**

## Voice Services

The preeminent service provided by P25 is the transfer of voice (i.e., telecommunications) traffic and associated user information from one user to another user or group of users. Both P25 users and the P25 Standards have

- 
- 5 The P25 Compliance Assessment Program (CAP), for example, uses TIA-developed testing procedures to build conformance and interoperability testing requirements.
  - 6 While the baseline package of features, functions, and services are similar between different manufacturers, they are not identical for a multitude of reasons. Users should work with manufacturers to determine what is offered and how those offerings impact cross-manufacturer interoperability.

clearly-defined voice service needs for both conventional and trunking operations. Common voice services include the ability to perform:

- Group voice calls using talkgroups in trunking and user-selected voice channels in conventional systems
- Individual voice calls or unit-to-unit calls
- Emergency group calls, and
- Broadcast voice calls to select groups of users, or all users, on a system.

The P25 Standards define how these calls are handled by the system, depending on whether the call is:

- Group or individual
- Emergency, priority (trunking only), or preemption (trunking only)
- Addressed or unaddressed (conventional only)
- Message or transmission trunked (trunking), repeater hang-time (conventional), and
- Encrypted or unencrypted.

To use voice services over system infrastructure, an SU must interact with system resources to streamline the transmission and reception of P25 voice calls. In conventional systems, features such as busy channel lockout, monitoring, and squelch control (e.g., normal squelch, selective squelch) enable the SU to transmit and receive over the desired channel(s). In trunking systems, the trunking controller facilitates system resources, unit registration (full registration or location registration), talkgroup affiliation, and other mobility management functions needed to establish voice calls.

## Data Services

Data services require different messaging protocols and procedures than those used in voice services. P25 supports packet data, which breaks data messages into error coded Packet Data Units (PDU) of varying lengths. PDUs are encoded using either the Internet Protocol (IPv4) bearer or the CAI bearer, and delivery of PDUs may be confirmed or unconfirmed.

Packet data enables the delivery of data elements used in P25 data services such as location services and encryption key management. Other data services, such as Over-the-Air Programming (OTAP), leverage the same data bearers but are not explicitly defined within the standards nor considered P25 services.

As technology continues to evolve, additional data capabilities may be defined to leverage data packet protocols and configurations to deliver the standard P25 datagram.

## Control Data Packets and Supplementary Data Services

P25 control messages are short, standardized data packets used primarily for trunking control but also applicable to supplementary data services used in both conventional and trunked systems. In trunked systems, the controller

sends P25 control messages over the control channel(s) to track SUs, grant RF resources, establish voice and data services among appropriate users, and enable supplementary data services.

Supplementary data services are control features that enhance or modify the traditional voice or data service.

On a trunked system, these messages are transmitted over the control channel(s). On a conventional system, they are transmitted over traffic channels using conventional control messages.

P25 supplementary data services include:

- Emergency alarm and cancel
- Radio unit monitoring
- Radio check and detach
- Status messages, updates and query
- Talking party identification
- Call alerting
- Individual and group regrouping, and
- Radio inhibit/uninhibit.

## Security Services

Security services include the encryption of voice, data, and signaling information, as well as OTAR and other key management mechanisms for P25 equipment and systems. These services are not used by all P25 systems but should follow defined P25 Standards when selected as an option to avoid interoperability challenges arising from disparate key management or encryption protocols.

## Encryption and Encrypted Calls

Encryption algorithms and encryption keys are used to establish encrypted calls. Encryption is the conversion of data into a form called a “cipher text” that cannot easily be understood by unauthorized personnel. Decryption is the process of converting cipher text back into its original form so it can be understood by the receiving user. P25 encryption must use one of the following encryption algorithms:

- Advanced Encryption Standard (AES) 256, or
- Data Encryption Standard (DES) 56.



**Note that DES is an outdated encryption algorithm that is easily compromised.** The National Institute of Standards and Technology (NIST), which develops cryptographic standards and guidelines for protecting information in federal communication systems, withdrew its approval of DES in 2005, and federal agencies are prohibited from using DES except for interoperability with legacy systems. NIST, the Federal Partnership for Interoperable Communications, and the National Law Enforcement Communications Center, which issues national interoperability encryption keys, all strongly recommend that public safety organizations use AES for encryption.

## Key Management

Encryption keys are necessary to authenticate and establish encrypted communications and must be carefully managed to ensure the integrity of encrypted systems. Traditional methods for updating encryption keys require bidirectional transfer of unencrypted and encrypted key variables from the key fill device (KFD) to the equipment containing the encryption service using a standardized messaging protocol defined by the Key Fill Interface (KFI). Remote key management is possible using OTAR through the Key Management Facility (KMF) standard. For use cases requiring encrypted interoperability between radios managed by different KMFs, the P25 Inter-KMF-Interface (IKI) and the future addition of KMF to KFD specifications to the KFI standard (currently under development) provides options for key transfers among KMFs and KFDs, regardless of manufacturer.

Considerations for key management include:

- KFD interoperability with end user radios
- Common interface between KMFs through the use of the IKI (existing P25 Standard)
- Common interface between KFD and KMF (under development), and
- A key management system with common key management commands, OTAR functionality, and configuration options.

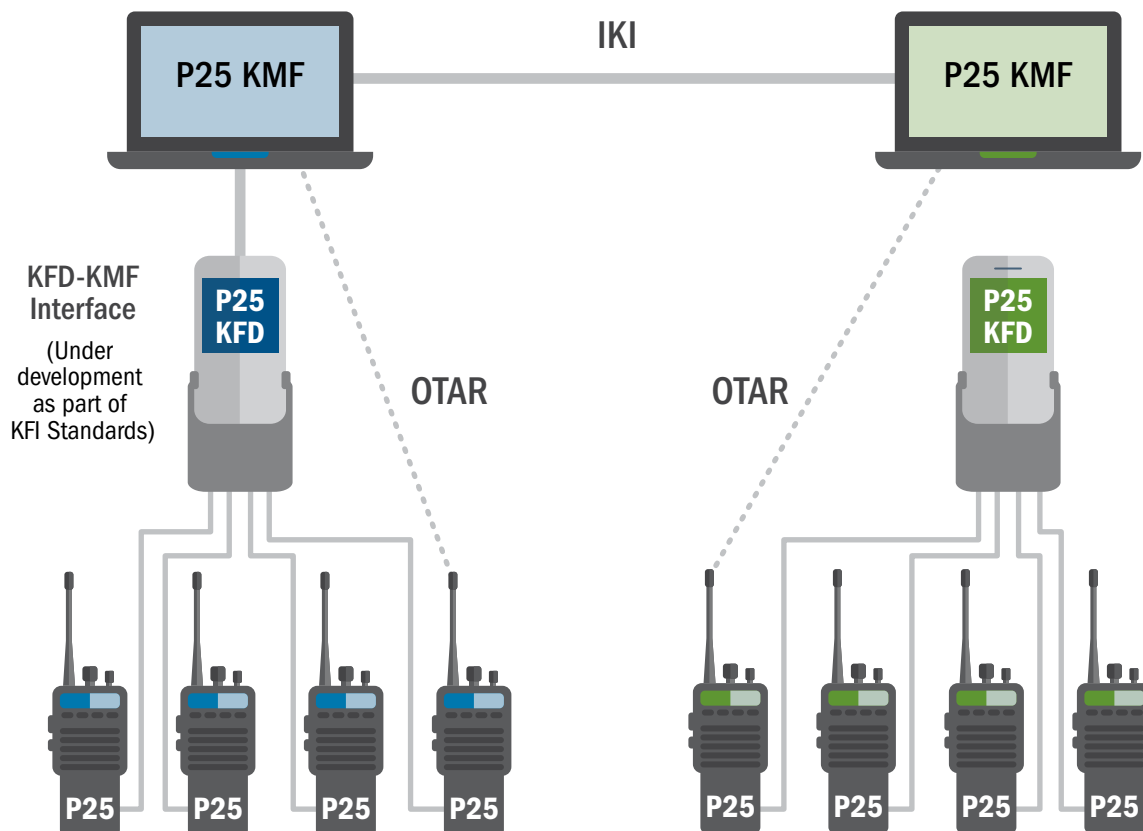

Figure 2 – P25 Security Services Key Management Overview

## Location Services

P25 location services allow location service host systems (LSHS) such as mapping software to receive location information from SUs within the P25 coverage area. Within the standards, location services are classified into two tiers:

- **Tier 1 Location Services** support a simple SU to SU interface appropriate for real-time field incident applications where the LSHS is resident on a portable device. Used only in conventional systems, Tier 1 Location Services send an SU's Global Positioning System (GPS) information directly to another SU and do not provide a mechanism to route location information to a host device on a fixed network.
- **Tier 2 Location Services** support a more complex application protocol that enables an SU's GPS location information to be routed to a host device on a fixed network. Used with both conventional and trunked systems, Tier 2 Location Services enable bi-directional data exchange between SUs and the LSHS and more advanced control over when and how the SU sends its location information.

## Subscriber Management Functions

Subscriber management enables system administrators to dynamically manage and configure their radio fleet. Manufacturers have developed software tools and features to support SU configuration and monitoring by elements of the fixed network equipment (i.e., infrastructure). These features are often proprietary to each specific system and are outside the scope of P25 Standards. Subscriber management functions often include the following:

- SU setup and tracking functions enabled by the CAI between SUs and network infrastructure
- Over the air programming for remote updates
- Subscriber database management tools to dynamically assign and monitor users on a system or talkgroup, and
- System status monitoring tools for the dispatcher or system administrator to track system status.

## Upcoming Features and Functions

P25 systems continue to evolve to accommodate user feedback and technology advances. P25 Standards under development include:

- LLE – protects control channel control messages and hides group/individual IDs.
- LMR and long-term evolution (LTE) interworking – provides standard interfaces and specifications to support LTE and LMR interconnection and interoperability.



---

## SECTION 2

---

# P25 Infrastructure and Interfaces

P25's digital signaling and standardized interfaces allow for design flexibility and advanced features not available in analog systems. Depending on the P25 manufacturer and specific user needs, P25 infrastructure can be configured to support a range of functions from basic voice services to advanced data features. P25 can support different system types, including:

- P25 conventional – FDMA/P25 Phase 1 only, and
- P25 trunking – FDMA/P25 Phase 1 or TDMA/P25 Phase 2.

The system can be further designed to support different RF configurations such as simulcast, multicast, and P25 voting to provide the appropriate level of inbound and outbound RF coverage using available RF resources (i.e., licensed frequencies).

Regardless of system type and infrastructure configurations, the P25 system infrastructure should communicate with SUs and other system components using standardized P25 interfaces.

# General P25 System Types

The items listed in **Appendix B – List of User Needs for P25 Infrastructure** are the basis of the P25 Standards, which are implemented into available P25 radio systems.

## Conventional and Trunking Modes

When capturing user needs and requirements for a P25 system, the first step is to identify whether the system or prospective system is conventional or trunked. This decision impacts system capacity and infrastructure requirements, subscriber units, and other system considerations.

### Conventional

A **P25 conventional system**, the most basic type of P25 system, consists of P25 fixed station repeaters (also known as a base station) and other site equipment that extend the range of two or more SUs during a P25 radio call. P25 conventional systems use 12.5 kilohertz (kHz) traffic channels, with each channel serving as a single talkpath capable of supporting a single speaker at once. In a conventional system, users must manually select the specific radio channel they want to communicate on and its operating characteristics. There are three conventional configurations:

- Direct mode – SU to SU,
- Repeat mode – SU to repeater to SU, and
- SU to console mode – SU directly to console.

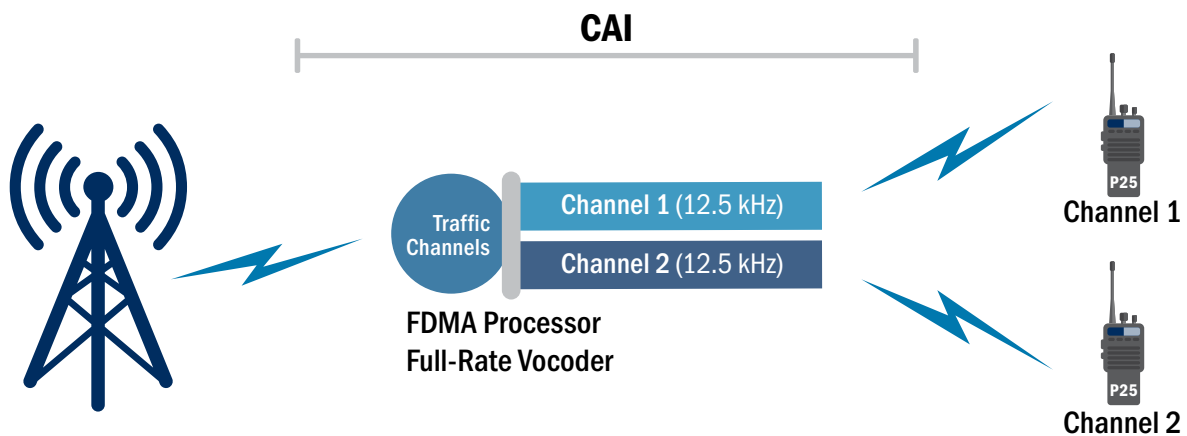

Figure 3 – FDMA Conventional

Access to a P25 conventional repeater is typically achieved via a network access code (NAC), which the repeater or SU uses to authorize incoming transmissions. Conventional P25 systems use phase 1 FDMA CAI for base station-to-SU and SU-to-SU transmissions.

# Trunking

A **P25 trunking system** introduces several advantages over a conventional system through the addition of a control channel and associated mobility control functions such as unit registration and group affiliation. Just as in a conventional system, the fixed station provides the physical communications channel, or RF resource, needed to establish a talkpath. However, trunking infrastructure improves spectrum efficiency and network control by dynamically assigning RF resources (i.e., channels) such that users can share a pool of RF channels. In a trunked system, the user selects a talkgroup and is automatically assigned an open radio channel. A trunked system can also assign call priority or preempt (override) calls in progress based on the call type. The system infrastructure manages this automated process using control logic transmitted over either a dedicated control channel (always active) or composite control channels (channel can be used for control or voice, but not at the same time). The trunking controller may be centralized at the core, decentralized at the RF sites, or both, depending on the manufacturer. Radio access schemes, vocoder rates, and different modulation techniques account for the main differences between P25 Phase 1 (conventional and trunking) and Phase 2 (trunking only) systems that allow Phase 2 Trunking to more effectively use RF resources.

## Phase 1 Trunking (FDMA)

P25 Phase 1 offers trunking features through the FDMA CAI, FDMA trunking procedures and FDMA control channels. Phase 1 uses 12.5 kHz traffic and control channels to carry voice or data at a full rate of 9600 bits per second (bps).

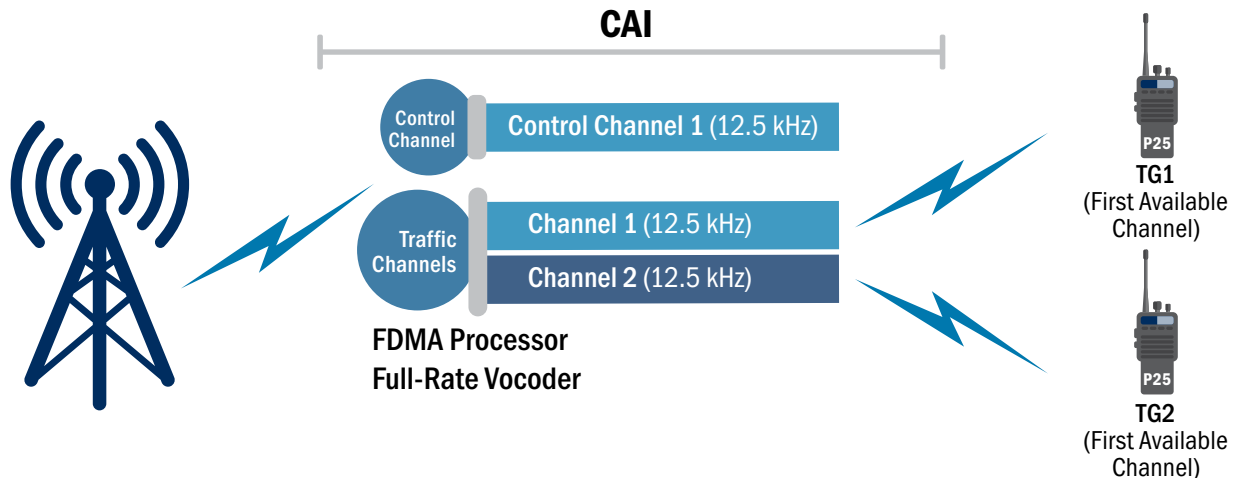

Figure 4 – FDMA Trunking

## Phase 2 Trunking (TDMA)

P25 Phase 2 trunking provides users with similar features as P25 Phase 1 trunking, but uses TDMA CAI, TDMA procedures (TDMA is trunking only) and FMDA control channels<sup>7</sup>. Using timed data packets, the system can support two separate conversations near-simultaneously on a single 12.5 kHz channel. This results in an effective channel bandwidth of 6.25 kHz per conversation and voice or data rates of 3800 bps. TDMA allows a system to support the same amount of traffic with fewer fixed stations (and physical channels) than would be required on a Phase 1 trunked

<sup>7</sup> TIA TR-8 has developed specifications for the TDMA control channel, so they may become available in the future

system. Data traffic channels are currently defined only for FDMA. FDMA and TDMA control channels support the same features and services; FDMA and TDMA voice channels also support the same features and services.

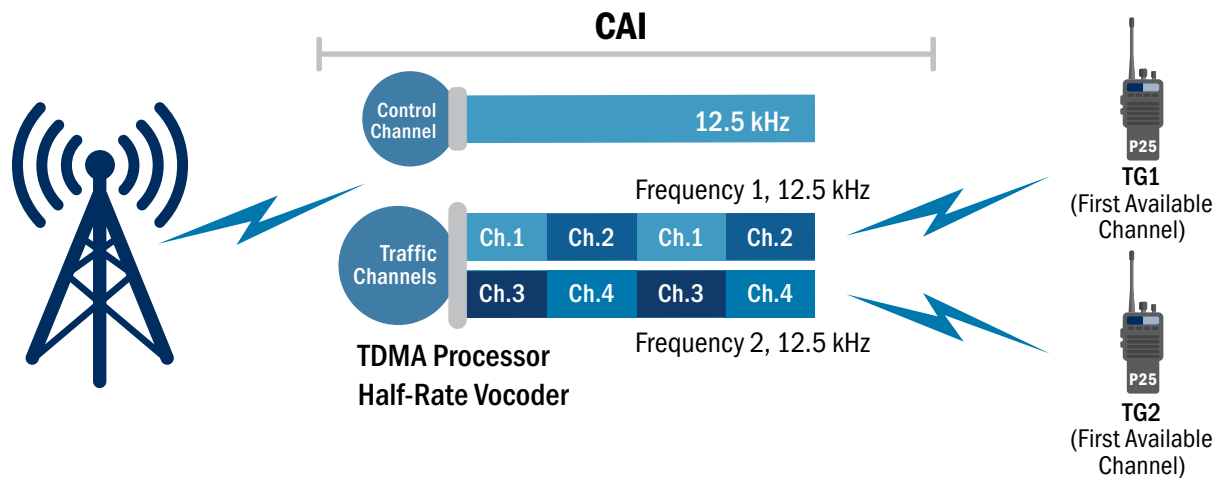

Figure 5 – TDMA Trunking

	Phase 1 FDMA	Phase 2 TDMA
<b>Channel Frequency</b>	12.5 kHz	6.25 kHz*
<b>Configuration Options</b>	Conventional and/or Trunked	Trunked Only
<b>Air Interface</b>	FDMA CAI (Um) <sup>8</sup> for Control and Traffic Channels	FDMA CAI (Um) for Control Channels, and TDMA CAI (Um2) for Traffic Channels
<b>Vocoder</b>	Full Rate (Improved Multi-Band Excitation [IMBE], Advanced Multi-Band Excitation [AMBE+])	Half Rate (IMBE, AMBE+2)

Figure 6 – Phase 1 and Phase 2 Comparison

\* Two-slot TDMA uses 12.5 kHz channels, but can handle two simultaneous voice and/or data transmissions.

### ANALOG AND DIGITAL INTEROPERABILITY

P25 is a digital radio standard and P25 systems operate in digital mode; however, to maintain compatibility with analog operations and provide options for gradual transition, some P25 fixed stations can also operate in analog conventional mode in compliance with TIA/Electronic Industries Alliance (EIA) 603.

While proprietary solutions exist in the marketplace, the P25 Conventional Fixed Station Interface is the standardized wireline interface between analog fixed stations and their host on the P25 system core. Either the Analog Fixed Station Interface (AFSI) or Digital Fixed Station Interface (DFS) variant can enable compatibility with traditional analog interfaces and features supported by the analog fixed station.

8 Descriptions of the Um and Um2 interfaces can be found on page 21, Table 1 - P25 Interfaces Overview.

## Simplex, Half-Duplex, and Full-Duplex Operations

P25 SUs and some P25 base stations may operate in **simplex mode**, where they can only transmit or receive on a single frequency (i.e., one direction only) in a conventional setup, or **half-duplex**, where they can transmit and receive on separate frequencies, but not at the same time. P25 repeaters operate in **full-duplex**, where they can receive and transmit simultaneously.

## Wide Area Networks

Conventional P25 systems range from a single repeater to a system of systems with hundreds of repeater sites, each with multiple repeaters (i.e., multiple traffic channels) and other Fixed Network Equipment (FNE) connected via IP backhaul and standardized interfaces. Similarly, trunked P25 systems range from a single trunking site to a complex network of repeater sites, FNE, standardized interfaces, and IP backhaul to support wide area network configurations.

Examples of FNE include:

- P25 repeaters and base stations
- Routers and switches
- Antennas and RF processing equipment (i.e., RF chain for processing transmit and receive signals)
- Fixed terminals (network computers)
- Site alarms and heating, ventilation, and air conditioning
- Data/voice backhaul equipment interfaces, and
- Customer system and subscriber database interfaces.

If the P25 system or RFSS contains multiple base stations/RF sites, dispatch centers, and other FNE, a wide area backhaul network (shown as an IP network) is used to connect all system nodes.

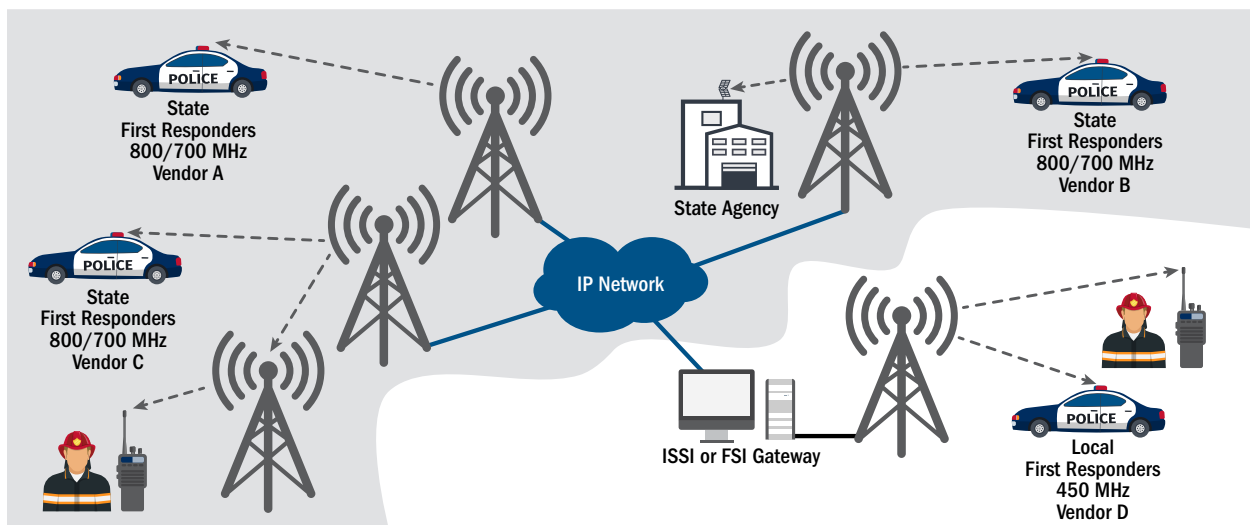

Figure 7 – Wide Area P25 Network with IP Backhaul

## Coverage Configurations

Although not covered in the P25 Standards, simulcast, multicast, and voting have been widely adopted by P25 manufacturers to provide wide-area P25 coverage using available and often limited RF frequencies. These wide-area networks involve a collection of sites using common frequencies that together form an RF subsystem.

### Simulcast

Simulcast is a RF coverage configuration used to maximize outbound repeater coverage area in P25 systems. Simulcast systems broadcast multiple near-simultaneous and time-synchronized transmissions on the same RF channel (i.e., same frequency) across a condensed area while limiting interference through advanced timing equipment. Simulcast allows a user to reuse assigned frequencies in a specific geographic area, thereby helping to reduce the overall frequency/channel licensing requirements. Simulcast also provides greater in-building penetration in areas where in-building coverage is a concern. Not every user would benefit from a simulcast configuration. Costs of equipment versus available spectrum licenses in the user's area need to be considered.

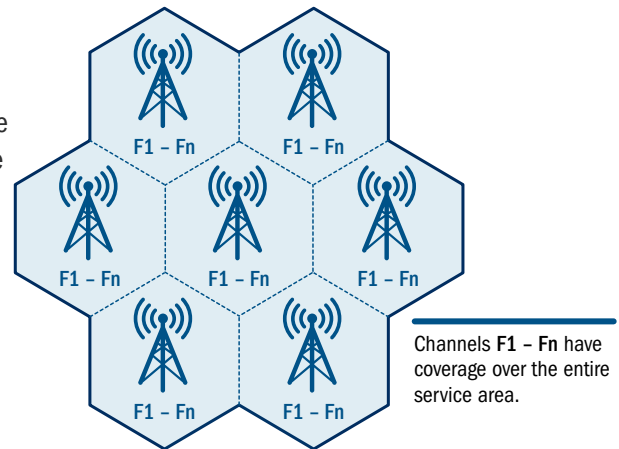

Figure 8 – Simulcast Layout

### Multicast

Multicast functions by making simultaneous transmissions at multiple sites using different RF channels (i.e., different frequencies). Frequencies can be reused, but this arrangement requires that the same frequency is never used in adjacent sites, thus eliminating co-channel interference from multiple sites at the cost of requiring additional frequencies and users to change channels as they move between sites.

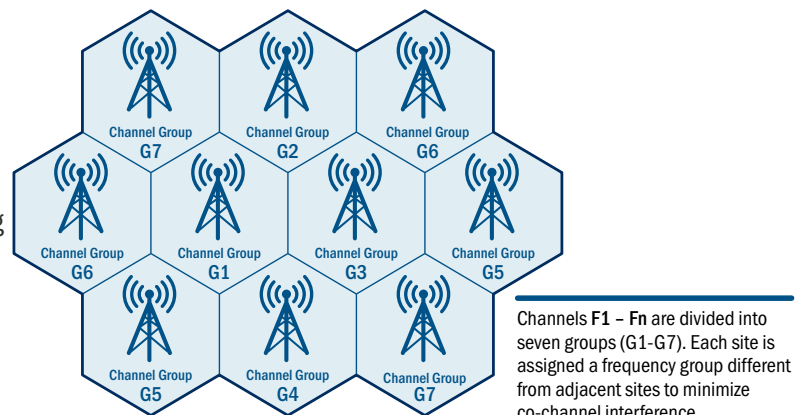

Figure 9 – Multicast Layout

### Voting

Voting is used to maximize inbound RF signals received by base station repeaters. Voting systems identify the strongest RF transmissions received from several locations/resources and pass the highest-quality audio to the system for use and rebroadcast. This is achieved via advanced voting receiving equipment, which uses received signal strength indication and bit error rate to determine which audio source should be selected. Voting configurations differ from system to system and may include remote voting sites to extend operational range. Remote voting sites are typically used in areas lacking inbound coverage (e.g., in certain types of buildings) or in other applications where the outbound transmission can be “heard” by a subscriber but the inbound transmission quality is variable.

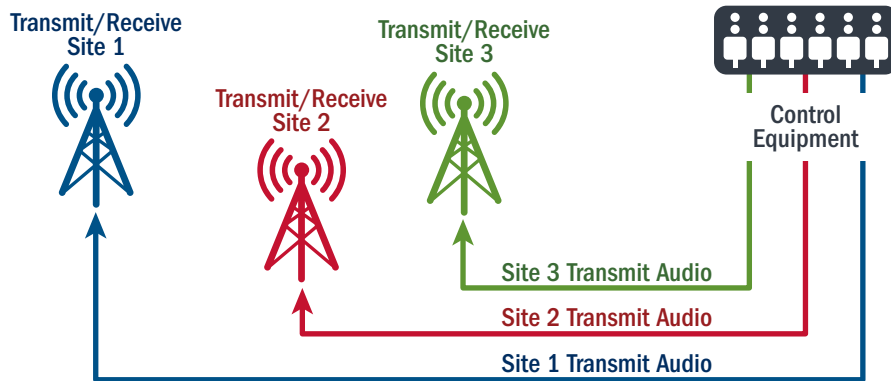

Figure 10 – Simulcast Voting Example. In this diagram, signals received at multiple sites are sent to the control equipment, where a voting comparator chooses the best signal to rebroadcast across the system.

Multi-Site Concept	Description
<b>Simulcast</b>	Each site uses the same frequencies over a wide-area. A timing system minimizes interference between adjacent sites.
<b>Multicast</b>	Each site uses a group of frequencies such that adjacent sites use different frequency groups.
<b>Voting</b>	If a transmission is received at multiple sites, voting compares the signals and selects the strongest one.

In practice, outbound coverage techniques such as simulcast or multicast are used with inbound techniques such as voting to provide the required level of mobile and portable coverage. Individual sites are then selected and configured to account for coverage needs, available frequencies, and interference considerations. It should be noted that simulcast systems always include voting, but voting may be used without simulcast.

### P25 STANDARDS AND COVERAGE

The P25 Standards do NOT cover site design, site hardening, and backhaul selection, nor do they dictate decisions on simulcast, multicast, voting, or other coverage configurations. Descriptions of these concepts are provided solely for awareness.

## P25 Network Control Elements

Network control elements are used to manage SU movement and voice and data traffic flow across the network.

While conventional systems only use traffic channels, trunked systems rely on control channels, control channel data packets (i.e., link layer), and complex system intelligence within the trunking controller to manage functions such as:

- Automatic and manual authentication between SUs and FNE
- Subscriber roaming, including:
  - » Intra system (between sites with the same system ID – Trunking only),
  - » Inter system (between sites with the same Wide Area Communications Network (WACN) ID but different system IDs – Trunking only),
  - » Inter WACN (between sites with different WACN and System IDs – Trunking only)
  - » Manual and automatic roaming
- Talkgroup affiliation
- User registration and de-registration onto a system, and
- Dynamic allocation of available RF resources to support voice calls and data services.

Conventional	FDMA Trunking	TDMA Trunking	
Traffic Channel (TC) 1	Control Channel (CC) 1	CC1*	
TC 2	TC 1	TC 1	TC 2
TC 3	TC 2	TC 3	TC 4

Figure 11 – Example of logical channel assignment for conventional and trunking systems with three RF channels (repeaters).

\* Please note that two-slot TDMA trunking currently uses FDMA control channels with TDMA extensions to enable backwards compatibility. However, a new addition to the P25 suite of standards defines a TDMA control channel (6.25 kHz) for P25 trunking operation.



# P25 Interfaces and Services

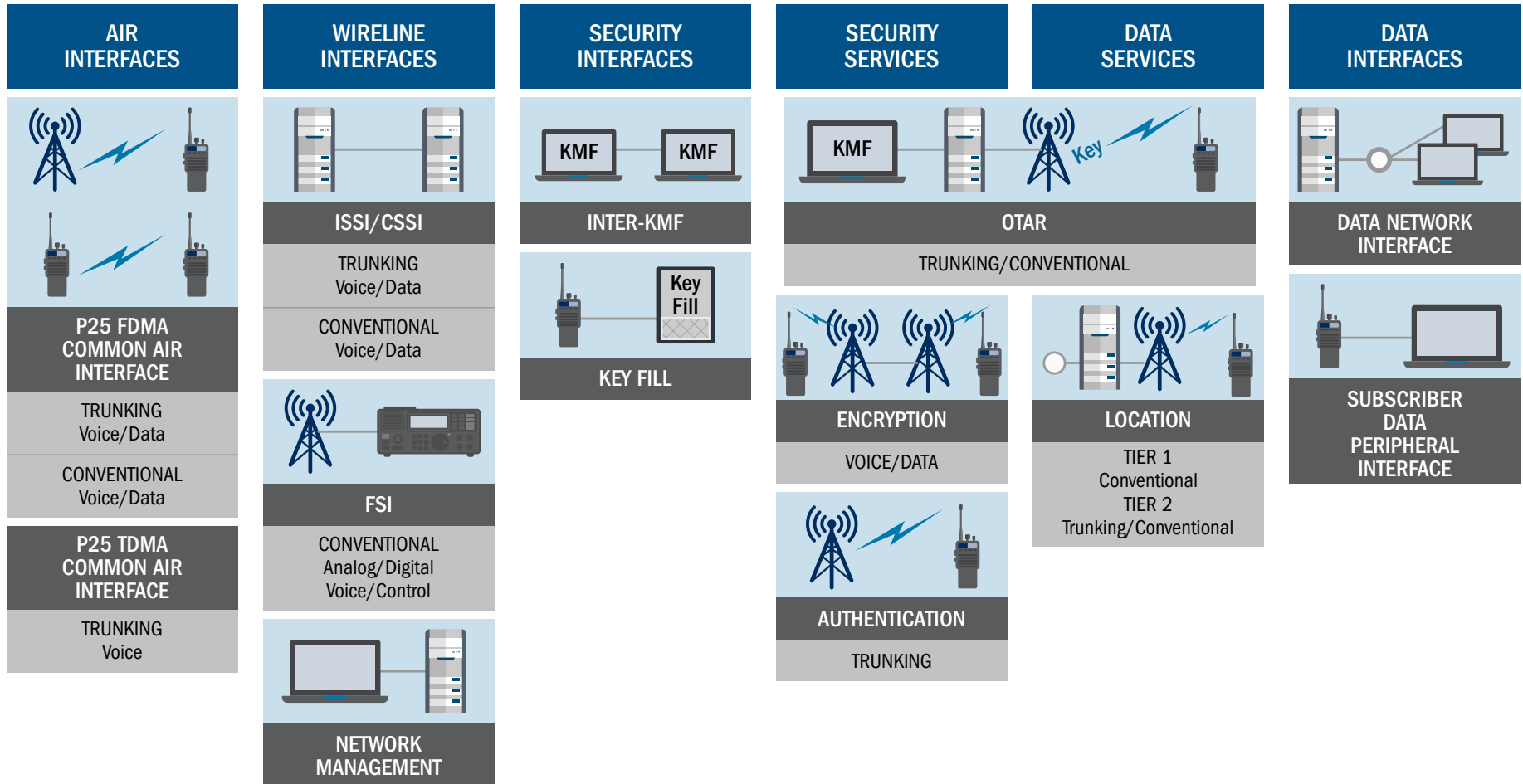

Figure 12 – P25 Interfaces and Services

The P25 Standards define interfaces and their corresponding protocols that enable standardized transmission of voice and data across P25 system components. These interfaces are critical to the interoperability of key P25 features and functions, and include those listed in **Table 1** and **Table 2**.

*Table 1 – P25 Interfaces Overview*

Interface	Standards Abbrev. *	Description	Connections
FDMA Common Air Interface (CAI)	Um1	The air interface between mobile and portable equipment and the system infrastructure (RFSS) of Phase 1, conventional or trunked FDMA systems. This allows P25 SUs to interoperate with P25 system infrastructure, regardless of manufacturer.	SU to SU, SU to RFSS
TDMA Common Air Interface (CAI)	Um2	The air interface between mobile and portable equipment and the system infrastructure of Phase 2, trunked TDMA systems. This enables P25 SUs to interoperate with P25 system infrastructure, regardless of manufacturer.	SU to RFSS
Fixed Station Subsystem Interface (FSSI or FSI)	Ef	Interface between a fixed station (including repeater) and the P25 RFSS. This standard allows the end user the choice and selection of equipment deployed in the field.	Base Station to RFSS/Console Subsystem
Inter-RF Subsystem Interface (ISSI)	G Interface	Interface to connect multiple RFSSs into wide area networks using industry standard protocols. The ISSI enables interoperability between RFSSs from different manufacturers, using different technologies (FDMA, TDMA, etc.), or on different RF bands.	RFSS to RFSS or other systems
Console Subsystem Interface (CSSI)	Ec	Interface between a console subsystem and a trunked or complex conventional P25 RFSS. The CSSI allows consoles from different vendors to operate on a single P25 radio system.	Console Subsystem to RFSS
Inter-Key Management Facility (KMF) Interface	IKI	Interface between multiple key management facilities, regardless of manufacturer.	KMF to KMF
Key Fill Interface (KFI)	KFI	Common interface between the KFD and SU, allowing for transfer of keys from KFD to SU. The KFI is currently being updated to include specifications for KFD to KMF interconnection.	KFD to SU

\* These abbreviations are sometimes used in P25 Standards documentation to denote P25 interfaces.

## P25 Common Air Interface (CAI) – Um Interface

The Project 25 Common Air Interface or “P25 CAI” is used to describe the standard for digital voice modulation (digital audio) and is the core element of the P25 Standards. CAI standards specify the type of digital signals transmitted by compliant radios and how those transmissions are formatted.

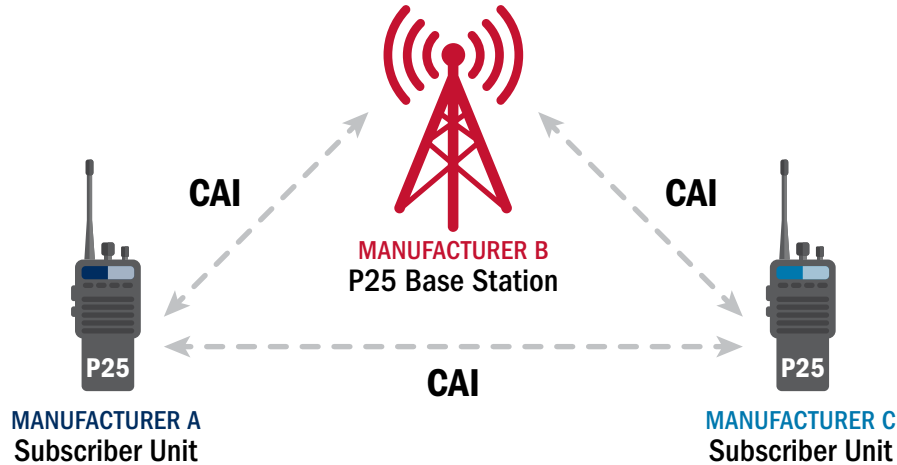

Figure 13 – Common Air Interface

One radio using P25 CAI should be able to communicate with any other P25 CAI radio or repeater/base station regardless of manufacturer. P25 CAI uses a standardized method for digitizing voice called Improved Multi-Band Excitation (IMBE).<sup>9</sup> The voice encoder-decoder (vocoder) samples the audio input at the microphone and produces a digital stream that represents the sound; this digital stream is then transmitted. The receiver sends this digital stream to the vocoder in its radio, which is then used to produce a synthetic equivalent (of analog audio) of the input sound.

One item to note when discussing the P25 CAI is the difference between P25 Phase 1 and P25 Phase 2. Although the vocoders in both Phase 1 and Phase 2 radios convert audio streams into compressed digital streams, Phase 1 operation uses a “full rate” vocoder while Phase 2 operation uses a “half rate” vocoder. This difference allows Phase 2 radios to operate in a TDMA environment, giving the system the ability to use a single RF resource or channel to support two voice calls. Phase 2 radios should be backwards-compatible with Phase 1 radios or systems, but not vice versa (i.e., a Phase 1 radio would not function on a system that calls for Phase 2-only equipment or talk-paths).

## P25 Fixed Station Subsystem Interface (FSSI or FSI) – Ef Interface

The P25 Fixed Station Subsystem Interface (FSSI), more commonly known as FSI, specifies a set of messages that support voice and data services between a conventional fixed station (including repeater) and the P25 RFSS or console subsystem. The analog and digital variants of the FSI (AFSI and DFSI) may be used to support analog and digital fixed stations respectively. The AFSI supports conventional FM RF stations via an analog connection, and the DFSI supports P25 FDMA stations via an IP-based digital connection. Both the analog and digital versions of the FSI enable media transfer and station control signaling for functions such as station frequency selection and station NAC selection.

<sup>9</sup> Some radios use Advanced Multi-Band Excitation (AMBE+) vocoders, a newer version of the IMBE vocoder.

Applications of the FSI include:

- Connecting an analog or digital P25 FDMA fixed station to a conventional console/RFSS of another manufacturer
- Connecting an analog fixed station to a console/RFSS to enable communications with analog SUs, and
- Connecting conventional P25 resources into a trunked environment.

## Inter-RF Subsystem Interface (ISSI) – G Interface

The ISSI is a P25 Standard interface that can interconnect RF subsystems, including those built by different manufacturers and with different software versions, into wide area networks such that users on disparate networks connected via ISSI can communicate with each other. These wide area networks are also known as “system-of-systems” architectures.

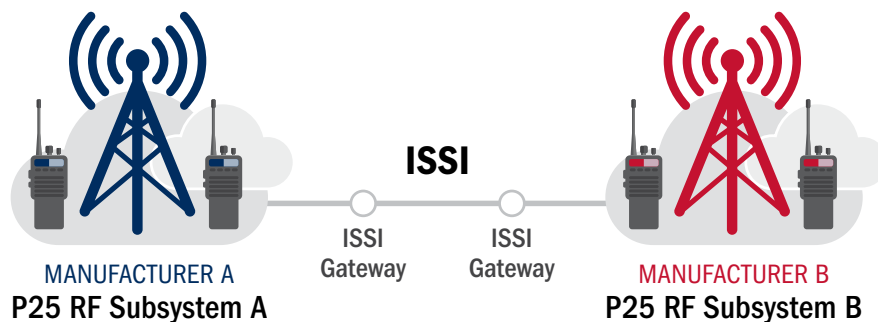

*Figure 14 – Inter-RF Subsystem Interface*

The wide area network connections using ISSI may provide an extended coverage area for SUs that are roaming while maintaining a level of control by the SU’s home system. ISSI also allows SUs from disparate systems to share common talkgroups when not roaming. To achieve this, ISSI supports messaging and procedures necessary to enable multiple RFSSs to track and locate SUs, set up and tear down calls, and transfer voice information to interested SUs. As the newest P25 interface, the ISSI uses Session Initiation Protocol and Real-time Transport Protocol, two standardized and commonly used voice over IP protocols, to provide the messaging between RFSSs.

## Key Management Interfaces

Key management interfaces such as the KMF to KMF Interface and the Key Fill Device Interface (KFI) allow for a standardized exchange of encryption key materials between KMFs, KFDs, and SUs regardless of manufacturer:

- The IKI enables key transfer among multiple KMFs in situations where users from disparate systems must share encryption keys.
- The KFI currently supports KFD to SU key transfers and is being expanded to include use with KMFs.



**NOTE:**

The P25 Console Subsystem Interface (CSSI) is used strictly with console subsystems and will be covered in **Section 3 – Consoles**.

## Non-P25 Interfaces

Some non-P25 interfaces are commonly used with P25 systems to provide desired functionality or capabilities. These interfaces use widely-accepted industry standards and are recognized by TIA TR-8. However, they are not defined or maintained by TIA TR-8, and therefore not considered part of the P25 Standards<sup>10</sup>.

*Table 2 – Non-P25 Interfaces Commonly Used with P25 Systems*

Non-P25 Interface Commonly Used with P25 Systems	Standards Abbrev.	Description	Connections
Network Management Interface (NMI)	En	Interface connecting network management equipment to all RFSS, regardless of manufacturer. The NMI enables a uniform network management scheme and the ability to connect a P25 system to existing network management system.	Network Management Equipment to RFSS
Telephone Interconnect Interface (TII)	Et	Open interface to a telephone network, supporting both analog and integrated service digital network (ISDN) telephone interfaces.	PSTN to RFSS
Mobile Data Peripheral Interface (MDPI)	A	A port through which laptops, terminals, or SU peripherals may be connected to a mobile or portable SU.	SU to Data Peripheral
Packet Data Host Network Interface	B	Interface for connecting the P25 system to host computers or other computer network connectivity.	Data Network

## Telephone Interconnect Interface – Et Interface

The Telephone Interconnect Interface (Et Interface) is the interface between P25 infrastructure (i.e., RFSS) and a PSTN. PSTN supports both analog and integrated services digital network telephone interfaces (where still available). The TII uses industry standards not defined by TIA TR-8; however, in situations where access to cellular communications or landlines might not be available, the Telephone Interconnect Interface allows users to connect to the telephone network via their P25 system and SU.

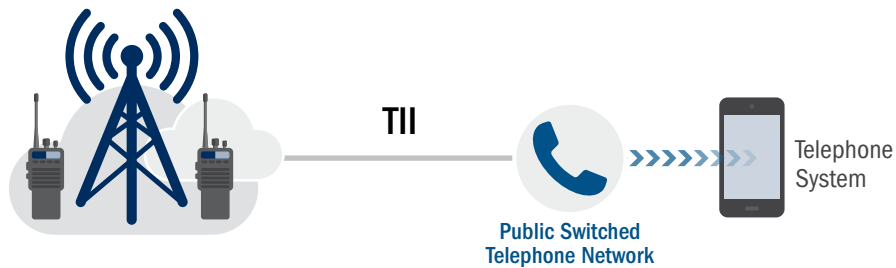

*Figure 15 – Telephone Interconnect Interface*

<sup>10</sup> A list of the P25 published standards can be found at: [www.project25.org](http://www.project25.org).

## Network Management Interface – En Interface

The Network Management Interface enables all network elements of an RFSS to be integrated with the system core infrastructure.

Network management in a P25 digital radio system has become critical to today's advanced radio systems. Public safety users have been moving to a network-based platform for some time, and most current-generation P25 systems (trunking and conventional) leverage networking advancements to better manage, control, and maintain equipment. The evolution has also facilitated advancement in software offerings from third-party vendors that can be used with a radio manufacturer's native, manufacturer-specific equipment. Available network management capabilities include:

- System real time alerts/alarms from remote equipment
- Network bandwidth monitoring systems and applications generating statistics
- Information on system call volumes
- Computer aided dispatching system interfaces, and
- Inventory tracking and control of SUs.

## Packet Data Host Network Interface

The Packet Data Host Network Interface designates the point where a P25 system communicates with external data hosts such as a Location Service Host System (LSHS) or other fixed data networks using IPv4 connections and IP addressing.

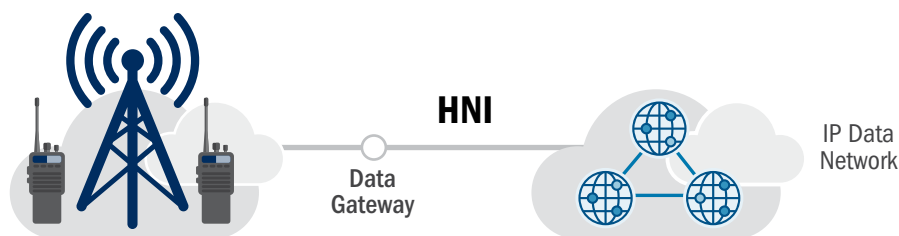

Figure 16 – Data Network Interface

This interface serves as the backbone of IP connectivity to external data sources required by P25 radio users. These standards allow system owners to use off-the-shelf mobile data terminals, computer equipment, manufacturer-specific network equipment, and remote data sources in a standard IP platform or larger data network.

A list of user needs associated with infrastructure and P25 interfaces can be found in **Appendix B – List of User Needs for P25 Infrastructure**.

### NOTE:

The non-P25 data peripheral interface used to connect SUs to data peripherals such as the mobile data terminal (MDT) is covered in **Section 4 – P25 Subscriber Units**.

---

## SECTION 3

---

# P25 Consoles

The console subsystem is a critical component in many public safety operations and for many public safety agencies. This section addresses console interfaces, standards, and tools used to enable console features and establish connections to subscriber equipment or other system infrastructure components.

# Console Description

Consoles come in several different configurations, including fixed and movable. Fixed consoles can be IP based and are hard-wired to a fixed or central location. The movable console is commonly called a “remote console” or “tactical console.” This configuration includes a terminal or user interface tied to a RF station or resource on the user’s P25 radio system. In both configurations, consoles are normally managed by a central server, which provides updates and user configuration information.

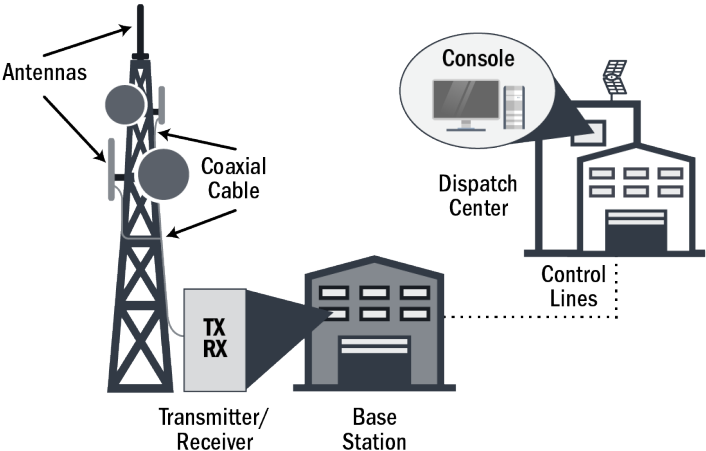

Figure 17 – Console Subsystem Connected to Base Station

The P25 Standards cover consoles embedded in an RFSS (i.e., part of the RFSS) or consoles that are connected to an RFSS via the CSSI (i.e., its own subsystem). However, some manufacturers also offer access to console resources via proprietary IP-based connections.

Connected consoles can simultaneously monitor numerous conventional channels and/or trunked talkgroups and control fixed station resources at the base station. When transmitting, consoles are granted high-priority use of system resources. In addition to a wide range of voice calls, consoles can use features such as:

- Individual and group regrouping
- Call interrupt
- Discreet listening
- Console takeover, and
- Other supplementary data services.

# Console Interfaces

Consoles can be configured as part of an RFSS, as its own console subsystem (considered its own RFSS), or a combination of the two. Both standardized and non-standardized interfaces are used to connect consoles.



## Console Subsystem Interface (CSSI) – Ec Interface

CSSI connects a console subsystem to the RFSS and is typically used for trunked P25 systems or complex conventional P25 systems. The CSSI also allows consoles from different vendors to operate on a single P25 radio system.

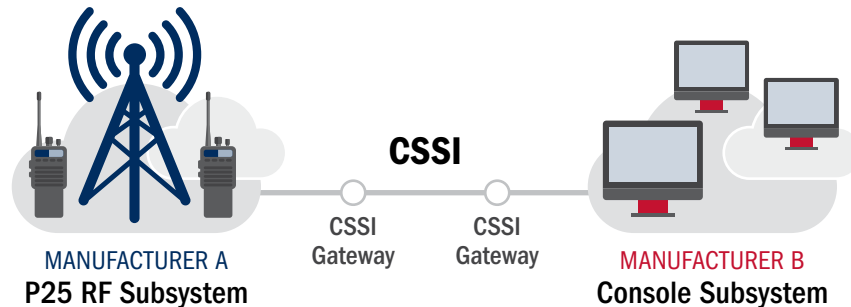

Figure 18 – Console Subsystem Interface

## Fixed Station Interface (FSI) – Ef Interface

The FSI interface, covered in **Section 2 – P25 Infrastructure and Interfaces**, allows for the control of conventional P25 base stations and repeaters. This control can come in the form of a digital FSI (DFSI) or as a wireline solution for analog RF equipment (analog FSI, or AFSI).

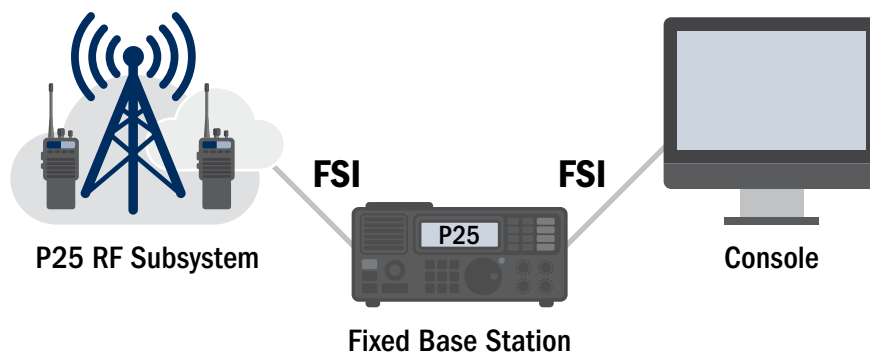

Figure 19 – Fixed Station Interface

## Inter-RF Subsystem Interface (ISSI) – G interface

The ISSI, covered in **Section 2 – P25 Infrastructure and Interfaces**, is typically used to allow overlapping or adjacent P25 systems to interoperate. However, in implementation, this interface also allows a native or embedded console system to communicate with another RFSS through an ISSI connection.

## Non-Standard Interfaces

In many embedded console systems, manufacturer-specific interfaces provide direct connections between same-manufacturer or licensed consoles and infrastructure equipment. Additionally, older console systems may or may not be able to be retrofitted with software or firmware compliant with new standardized wireline interfaces such as CSSI or ISSI.

The CSSI protocol shares a significant set of protocols with the ISSI. Together with FSI, these wireline interfaces are IP-based. In addition, the FSI has an analog variant (i.e., AFSI) that can use 4-wire audio circuits (either ear and mouth (E&M) or Tone Remote Control [TRC]).

The primary documents of the CSSI, FSI and ISSI interfaces have been published, and TIA TR-8 continues to revise the published wireline standards documents<sup>11</sup>. These revisions correct errors and provide clarifications and enhancements to the protocol.

A list of user needs associated with consoles can be found in **Appendix C – List of User Needs for P25 Consoles**.

---

<sup>11</sup> A full list of approved P25 Standards can be found on the [Project 25 Technology Interest Group \(PTIG\) website](#).

---

## SECTION 4

---

# Subscriber Equipment

Subscriber units are portable and mobile radios that allow the end user to communicate with other SUs with or without the presence of P25 network infrastructure. Portable units are handheld radios with relatively low transmit power designed for on-foot and in-building use. Mobile radios are typically vehicle mounted, have greater transmit power, and often use mounted vehicular antennas. SUs operating under P25 guidelines and standards can generally be configured to operate with and across multiple P25 public safety systems using the P25 CAI. This includes interoperability with different manufacturers' system infrastructure, provided that SUs and infrastructure are operating on the same frequencies and operational modes (i.e., Conventional, Trunking Phase 1, Trunking Phase 2).

# P25 Subscriber Units

SU capabilities vary greatly depending on user needs and manufacturer offerings. Variations include:

- Conventional and/or trunked
- Single or multiple public safety frequency bands
- FDMA/P25 Phase 1 and TDMA/P25 Phase 2
- Encrypted and/or unencrypted, and
- Voice and/or data.

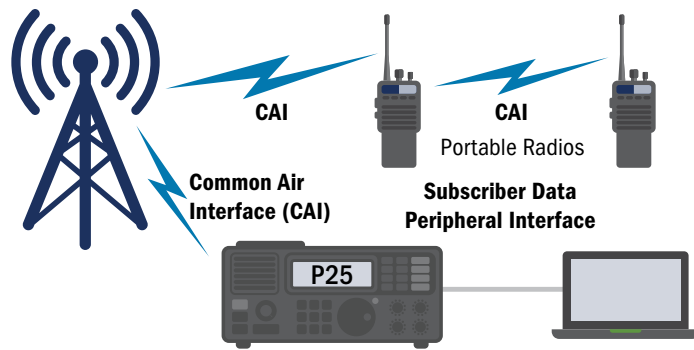

Figure 20 – Subscriber Unit Overview

Many SUs support interoperability by allowing users to switch between modes to match system and other SUs with which they need to interoperate. P25 SUs are capable of many features, functions and services listed in **Section 1** and **Appendix A**.

All systems and subscriber equipment use the P25-defined vocoder<sup>12</sup> (IMBE and AMBE+2). Furthermore, systems and subscriber equipment intended to support encryption use P25-defined encryption algorithms. These are required to facilitate mixed-mode (FDMA/TDMA) end-to-end delivery of both unencrypted and encrypted voice and data. Phase 1 uses full-rate vocoding; Phase 2 uses half-rate vocoding.

Other characteristics such as form factor, durability, heat resistance, and the presence of tactile buttons, while important to the end user, are not covered in the P25 Standards as to allow for innovation and competition.

## Subscriber Unit Interfaces

### Common Air Interface

Most SU features are enabled through standardized CAI (both FDMA and TDMA) messaging between the SU and system infrastructure, or directly between SU and SU (direct mode, FDMA only). The CAI is explained in more detail in **Section 2**.

### Mobile Data Peripheral Interface

The mobile data peripheral interface connects SUs to mobile data peripherals, such as mobile data computers (MDC) or other IP devices. This non-P25 interface uses standard IP connections and protocols to provide mobile access to IP data capabilities.

<sup>12</sup> The **vocoder** is the component of a radio that converts human voice into a digital signal for transmission.

# Digital Vehicular Repeater Systems

Among the advancements in modern P25 subscriber equipment is the ability to leverage Digital Vehicular Repeater Systems (DVRS). These DVRS units extend the range of subscriber operations by rebroadcasting a signal from an SU and retransmitting it over a more powerful transmitter, thereby extending the range of low-power P25 SUs.

Published P25 Standards enable vehicular repeaters but do not dictate their design or capabilities. Vehicular repeaters available in the market vary greatly, but generally allow for advanced features and functions, such as:

- Encryption pass-through
- P25 conventional operations
- P25 Phase 1 and 2 operations, and
- In-cabinet repeat<sup>13</sup>.

## P25 Compliance Assessment Program Testing

The Department of Homeland Security (DHS) voluntary P25 Compliance Assessment Program (CAP) allows manufacturers to have their subscriber units and system infrastructure tested by DHS-certified laboratories against specific P25 requirements such as CAI and encryption protocol compatibility. If their products meet those requirements, the manufacturers are permitted to market them as “P25 Compliant.”

As proof of compliance, manufacturers must submit summary test reports and declaration of compliance documents to the DHS CAP team for review and acceptance. End users should carefully review P25 CAP results related to products and understand which P25 requirements were tested and addressed.

Many grant programs and the [SAFECOM Guidance on Emergency Communications Grants](#) requires the purchase of “P25 compliant” equipment. A list of user needs associated with SUs can be found in **Appendix D – List of User Needs for P25 Subscriber Equipment**.

---

<sup>13</sup> In-cabinet repeat, or local repeat, is a legacy feature that allows repeaters to receive and transmit using squelch control instead of voting comparators

# Author's Note

Appendices A-D allow readers to quickly reference P25 features, functions, services, and user needs relevant to their work. Not all items are implemented by all manufacturers nor needed by all users; P25 user needs vary significantly based on system type, user roles, and other factors. **These lists are provided to indicate what may be possible with P25 and are not intended as a list of P25 user requirements for the purposes of acquisition or procurement.**

The P25 Steering Committee anticipates ongoing collaboration with P25 manufacturers, vendors, end users, and system operators to periodically validate and update these user needs tables.

## Appendices Table of Contents

<b>Appendix A – List of User Needs for P25 Features, Functions, and Services</b> .....	<b>A-1</b>
1.1. Voice Services .....	A-2
1.2. Supplementary Data Services .....	A-2
1.3. Location Services.....	A-3
1.4. Security Services.....	A-4
1.5. Other Services.....	A-4
<b>Appendix B – List of User Needs for P25 Infrastructure</b> .....	<b>B-1</b>
2.1. General System Needs .....	B-2
2.2. Mobility Control Elements.....	B-3
2.3. Common Air Interface.....	B-4
2.3.1. P25 Control Elements, Subscriber Management, and Call Processing Over the CAI .....	B-4
2.4. Inter-RF Subsystem Interface (ISSI).....	B-6
2.4.1. General ISSI Needs.....	B-6
2.4.2. Subscriber Roaming Management (Unique to ISSI) .....	B-7
2.5. Fixed Station Interface .....	B-8
2.5.1. Conventional Digital Fixed Station Interface (CDFSI) .....	B-9
2.6. Non-P25 Interfaces .....	B-10
2.6.1. Network Management Interface .....	B-10
2.6.2. Telephone Interconnect Interface .....	B-11
2.6.3. Packet Data Host Network Interface.....	B-11

<b>Appendix C – List of User Needs for P25 Consoles</b> .....	<b>C-1</b>
3.1. General Console Needs .....	C-2
3.2. Console Subsystem Interface .....	C-3
<b>Appendix D – List of User Needs for P25 Subscriber Equipment</b> .....	<b>D-1</b>
4.1. Features, Functions, and Services Support.....	D-2
4.2. Mobile/Portable Subscriber Unit General Requirements .....	D-2
4.3. Vehicular Repeater (VR) Capability .....	D-4
4.4. Mobile Data Peripheral Interface.....	D-6
<b>Appendix E – Features and Functions Applicable to Each Interface</b> .....	<b>E-1</b>
5.1. Modes.....	E-2
5.2. Voice Services (Section 1.1.).....	E-2
5.3. Supplementary Data Services (Section 1.2.) .....	E-2
5.4. Location Services (Section 1.3.) .....	E-3
5.5. Security Services (Section 1.4.) .....	E-3
5.6. Other Services (Section 1.5.) .....	E-3
<b>Appendix F – Additional Resources</b> .....	<b>F-1</b>
The Project 25 Technology Interest Group (PTIG) Website.....	F-2
“PTIG – Is P25 Public Safety Grade?” .....	F-2
“PTIG – Capabilities Guide, v1.7” .....	F-2
P25 Statement of Requirements, 2013.....	F-2
TIA Website, P25 Standards Suite.....	F-2
Codan – P25 Radio Systems Training Guide, 2013 .....	F-3
Tait Best Practices Website and Videos .....	F-3
Public Safety Wireless Network (PSWN) – Comparisons of Conventional and Trunked Systems, 1999.....	F-3
SAFECOM/National Council of Statewide Interoperability Coordinators (NCSWIC) Website.....	F-4
P25 Compliance Assessment Program (CAP) .....	F-4
<b>Appendix G – Acronyms</b> .....	<b>G-1</b>

---

## APPENDIX A

---

# List of User Needs for P25 Features, Functions, and Services

This section focuses on “end-user features, functions, and services” that rely on P25 interfaces and interactions between P25 subscriber units (SUs), consoles, and infrastructure. It provides users with information for discussing features and functions that might be relevant to their operations, without diving into detailed discussions of system architecture, configuration, or interfaces.



## 1.1. Voice Services

P25 Features, Functions, and Services	Description	Conventional Phase 1 FDMA	Trunking Phase 1 FDMA	Trunking Phase 2 TDMA	P25 Standard
Group Call	Routine group calls intended for a group of users or talkgroup in the radio system.	X	X	X	X
Individual Call	Also known as a unit-to-unit or private call, the individual call allows a SU to individually call another SU or console and communicate privately. This transmission is addressed to an individual subscriber.	X	X	X	X
Announcement Group Call	Allows a SU or console to use a dedicated talkgroup to make a call to a collection of talkgroups. "Announcement group" is transmission trunked only.		X	X	X
Broadcast Call	A one-way single transmission (i.e., no "hang time") group call.		X	X	X
Emergency Call	An emergency call, typically intended for a group, enables users to inform dispatch personnel of life-threatening situations and receive the highest priority level of voice channel access to the network.	X	X	X	X
System-Wide Group Call (System Call)	Enables coverage and reach to the broadest audience possible. When a system call is made, it will be received by all SUs and consoles registered on the system.		X	X	X
Priority Call	The system will prioritize call requests.		X	X	X
Preemptive Priority Call	The system preempts existing calls in order to service new calls and may attempt to ensure that no RF contention issues will occur before allowing preemption. Rules for audio preemption may be established by the system administrator.		X	X	X
PSTN Interconnect Call	Supports seamless communications between radios, dispatchers, and telephone subscribers; also supports standardized PSTN signaling. There are three modes of initiating a PSTN interconnect call: <ul style="list-style-type: none"> <li>• Buffered Mode – User enters all digits to be dialed into the SU, then presses send.</li> <li>• Live Key Mode – SU sends appropriate air interface signaling as each key is pressed.</li> <li>• List Mode – User chooses from a preprogrammed list of possible numbers to dial.</li> </ul>	X	X	X	

## 1.2. Supplementary Data Services

P25 Features, Functions and Services	Description	Conventional Phase 1 FDMA	Trunking Phase 1 FDMA	Trunking Phase 2 TDMA	P25 Standard
Transport of Talker ID	Ability to pass the Subscriber Unit ID (SUID) and/or Working Unit ID of the transmitting radio unit to all receiving parties.	X	X	X	X
Emergency Alarm (Emergency Alert)	Alarm notifies dispatch console of emergency status for the SU or talkgroup. The function is initiated by a mobile/portable SU and is always addressed to a group.	X	X	X	X

P25 Features, Functions and Services	Description	Conventional Phase 1 FDMA	Trunking Phase 1 FDMA	Trunking Phase 2 TDMA	P25 Standard
Emergency Alarm Cancel	An emergency state for the SU or talkgroup is cancelled by a mobile/portable SU.	X	X	X	X
Group Emergency Cancel	An emergency state for a talkgroup is cancelled by a mobile/portable SU or by a console.	X	X	X	X
Call Alert	Rather than voice-calling a radio and asking if that person is available, a call alert is made, the radio beeps and displays the ID of the caller, and the person receiving the call alert can then initiate the call.	X	X	X	X
Short Message	Data Messaging features that allows a SU or console to send a pre-defined numeric/text message to a destination.	X	X	X	X
Status Query	Ability for a SU or console to check or monitor the status of any SU in the system. The destination SU responds with a pre-defined data message.	X	X	X	X
Status Update	Ability to send predefined status messages.	X	X	X	X
Radio Unit Monitor	Causes a SU to key up in accordance with pre-programmed rules without requiring action from the destination SU.	X	X	X	X
Radio Check	A way for a dispatcher to check on the availability of a subscriber unit on a particular RFSS.	X	X	X	X
Radio Detach	Radio detach can be used by a dispatcher to cause a SU to be de-registered from the system.		X	X	X
Radio De-Authorization	Ability to remove a SU from the P25 system immediately or terminate services to it without having to inhibit the SU.		X	X	X
Radio Inhibit	Ability to disable a radio unit remotely, in case it is lost, missing, or stolen. An inhibited radio will appear to be inoperable.	X	X	X	X
Radio Un-inhibit	Ability to enable a radio unit remotely, in cases where a radio has been inhibited.	X	X	X	X

### 1.3. Location Services

P25 Features, Functions and Services	Description	Conventional Phase 1 FDMA	Trunking Phase 1 FDMA	Trunking Phase 2 TDMA	P25 Standard
Tier 1 Location Services	Support a SU-to-SU interface for the transfer of location data in Conventional Direct or Repeated mode operation. This approach is appropriate for real-time field incident applications where the location service host system is resident on a portable device.	X	X	X	X
Tier 2 Location Services	Utilizes a more complex application protocol to configure triggering and reporting of location data in the SU from a fixed host. Tier 2 users use datagram protocol/IP to allow routing and transport in a fixed network for communications to and from a fixed host or SU. This approach is appropriate in areas that contain the necessary infrastructure.	X	X	X	X

## 1.4. Security Services

P25 Features, Functions and Services	Description	Conventional Phase 1 FDMA	Trunking Phase 1 FDMA	Trunking Phase 2 TDMA	P25 Standard
Encrypted Call	Encrypted traffic over the air interface using block encryption protocol or other standardized encryption. P25 encryption algorithms include: <ul style="list-style-type: none"> <li>AES 256</li> <li>DES 128 (no longer accepted by NIST or recommended by encryption experts)</li> </ul>	X	X	X	X
Authentication	Provides a method for authenticating subscribers (SU authentication) and infrastructure (i.e., FNE) within a system using manual and automatic configurations.	X	X	X	X
Over the Air Rekeying (OTAR)	Transmitting or updating encryption keys by conveying the keys “over the air” so users do not have to manually rekey radios. Basic OTAR key management procedures include: <ul style="list-style-type: none"> <li>Change-RSI</li> <li>Changeover</li> <li>Delete-Key</li> <li>Hello</li> <li>Modify-Key</li> <li>Registration</li> <li>Rekey</li> <li>Warm-Start</li> <li>Zerorize</li> <li>Capabilities</li> <li>Delete-Keyset</li> <li>Deregistration</li> <li>Inventory</li> <li>Key-Assignment</li> <li>Modify-Keyset</li> <li>Set-Time-Date</li> </ul>	X	X	X	X
Encryption Key Update	Ability to update encryption keys using standardized interfaces (e.g., IKI and KFI).	X	X	X	X
Link Layer Encryption	Encryption of control channel messages.		X	X	X

## 1.5. Other Services

P25 Features, Functions and Services	Description	Conventional Phase 1 FDMA	Trunking Phase 1 FDMA	Trunking Phase 2 TDMA	P25 Standard
Over the Air Programming	Send firmware and other programs over the air to SUs (e.g., updates to SU software, software version, personality profile, or service programming).	X	X	X	
Text Messaging	Enables text messages to be sent from one unit to another. Text messages may be up to 256 characters in length and may be sent via SU keyboard or from data terminal devices connected to a SU.	X	X	X	
Interconnection with non-P25 Systems	Supports standard service signaling and bearer interface for interconnection with non-P25 systems.	X	X	X	

P25 Features, Functions and Services	Description	Conventional Phase 1 FDMA	Trunking Phase 1 FDMA	Trunking Phase 2 TDMA	P25 Standard
Audible Signaling (Alert Tones)	Use data messages in the system to initiate audible signals both in the subscriber units and in the consoles. Tones may be standardized (i.e., emergency, acknowledge, message indication, and channel marker tones) or personally programmed.	X	X	X	
Subaudible Signaling (squelch control, tone control, Continuous Tone-Coded Squelch System [CTCSS]/Digital Carrier Squelch [DCS])	Radios operating in the DCS mode are configured to unmute based on receiving carrier, ignoring both the received NAC and the received talkgroup ID.	X	X	X	
Manual Roaming	SU is able to establish a manual connection (i.e., manual registration and authorization) as it roams into a new RF site.	X	X	X	X
Automatic Roaming	SU is able to establish an automatic connection (i.e., automatic registration and authorization) as it roams into a new RF site.		X	X	X
Individual Regrouping	Allows an affiliated radio to be reassigned over the air to a new talkgroup without intervention from the radio user.		X	X	X
Group Regrouping	Allows multiple talkgroups and their affiliated radios to be regrouped into a single supergroup (with supergroup ID). The supergroup is a unique type of working group used for group regrouping.		X	X	X

---

## APPENDIX B

---

# List of User Needs for P25 Infrastructure

This section focuses on user needs that impact P25 infrastructure interoperability and a system component's or RFSS's ability to exchange voice and data messages across a range of P25 interfaces. With a focus on interoperability, site-specific and RFSS-specific configurations, coverage considerations, backhaul configurations, and other design options are outside the scope of this table.

## 2.1. General System Needs

P25 Infrastructure	Description	Conventional Phase 1 FDMA	Trunking Phase 1 FDMA	Trunking Phase 2 TDMA	P25 Standard
Channel Width/Bandwidth Compliance	Channel utilization of 12.5 kHz in Phase 1 and 6.25 kHz equivalency in Phase 2.	X	X	X	X
Efficient Use of RF Resources	Calls do not require resources at sites that do not contain addressed subscriber units (except simulcast RF subsystems).	X	X	X	X
FCC/NTIA Rules Satisfied	Satisfy FCC/NTIA rules for spectral efficiency and support existing FCC/NTIA channelization plans.	X	X	X	X
FDMA Phase 1 Backwards Compatibility Analog Conventional	Ability to coexist with Phase 1 and older analog systems, sharing the same segments of allocated RF spectrum without interfering with the function of existing adjacent-channel systems.	X	X		X
TDMA Phase 2 Backwards Compatibility	The P25 system is able to coexist with Phase 2 and Phase 1 systems, sharing the same segments of allocated RF spectrum without interfering with the function of existing adjacent-channel systems.			X	X
Adaptive to all Public Safety Bands	The system is, at a minimum, equally adaptive to all public safety mobile radio frequency bands and blocks of spectrum. Public safety bands include: <ul style="list-style-type: none"> <li>VHF Band (138 - 174 MHz)</li> <li>UHF Band (380 - 512 MHz)</li> <li>700/800 MHz Band (764 - 869 MHz).</li> </ul> This does not preclude its adaptability to other land mobile radio bands.	X	X	X	X
Manufacturer Specific Features	A standard method is specified for segmenting nonstandard (or potentially future-standard), value-added features between manufacturers to safeguard from unintentional interaction between subscriber units of different manufacturer's subsystems. No manufacturer proprietary extensions implement features that interfere with the operation of P25-compliant equipment. Manufacturers implement P25-compliant features whenever equivalent proprietary features are implemented.	X	X	X	
Multiple System Configurations Capability	The system or subsystem is technically flexible to allow for single and multiple site systems, voting, and simulcast designs.	X	X	X	X
Orderly System Expansion	The system allows for continued enhancement of standardized functions and features so that the system can grow with user needs.	X	X	X	X
Co-Channel Operation	The system is resistant to interference from co-channel, adjacent-channel, and intermodulation effects, in a manner similar to CTCSS used in analog systems.	X	X	X	X
Out-of-Channel Emissions	Out-of-channel emissions of any future P25 standard for 25 kHz channel width or less shall be at least as spectrally pure as the out-of-channel emissions of the P25 Phase 1 FDMA standard.	X	X	X	X
Duplex Time Slot Operation	Fixed station equipment is capable of operating in a duplex time slot mode on a single carrier frequency.			X	X

P25 Infrastructure	Description	Conventional Phase 1 FDMA	Trunking Phase 1 FDMA	Trunking Phase 2 TDMA	P25 Standard
Dynamic Allocation of Channel Bandwidth for Data	Transmission of digital data may use dynamic allocation of channel bandwidth, up to the maximum possible for a particular channel width.	X	X	X	X
Standard Signaling and Communications Interfaces	RFSSs support standard signaling and communications interfaces to be flexibly linked into wide-area networks via private or public networks.	X	X	X	X
IP-Based Capabilities	IP-based capabilities equivalent to those capabilities provided via the Conventional Analog Fixed Station Interface (CAFSI) when the digital fixed station is operating in analog mode.	X	X	X	X
Throughput Delay	<p>Defined as the transfer delay of voice information involving a calling SU and a called SU, respectively:</p> <ul style="list-style-type: none"> <li>Less than 250 msec in direct radio-to-radio communications.</li> <li>Less than 350 msec in radio-to-radio communications through a single conventional repeater</li> <li>Less than 500 msec in radio-to-radio communications involving a single RF subsystem. This requirement does not apply to conventional repeater chains (i.e., when two or more conventional repeaters are serially interconnected within a single RFSS).</li> <li>Less than 1,000 msec in radio-to-radio communications involving two or more RF subsystems.</li> </ul>	X	X	X	X
Graceful Degradation (fallback/failover)	Support fallback/failover modes such as single site mode, site trunking, and conventional fallback in the event of system degradation.	X	X	X	X

## 2.2. Mobility Control Elements

P25 Infrastructure	Description	Conventional Phase 1 FDMA	Trunking Phase 1 FDMA	Trunking Phase 2 TDMA	P25 Standard
Call Processing Intelligence	RFSSs contain all the control intelligence to support call processing and track unit location and roamers within the RFSS.		X	X	X
Secure Trunking Control Channel (Link Layer Encryption)	Security trunking control channel is provided. Security services include confidentiality and message replay protection. Encryption is the mechanism for implementing these security services.		X	X	X
Common Protocols and Coding Formats	To facilitate interoperable P25 CAI multi-mode (FDMA/TDMA) system design, all system and subscriber equipment should use common (P25 defined) call setup/link protocols and ID coding formats.	X	X	X	X

P25 Infrastructure	Description	Conventional Phase 1 FDMA	Trunking Phase 1 FDMA	Trunking Phase 2 TDMA	P25 Standard
ID Structures	Up to 64,000 different RFSSs are uniquely identifiable. Each RFSS provides for at least 2,000 uniquely identifiable functional talkgroups or vertical partitions for distinct and separate organizations and at least 48,000 individually identifiable SUs per RFSS.	X	X	X	X
Assignment of Unique IDs	All manufacturers of P25 compliant systems follow P25 Guidelines to assign WACNs and System IDs.	X	X	X	X

## 2.3. Common Air Interface

Common Air Interface	Description	Conventional Phase 1 FDMA	Trunking Phase 1 FDMA	Trunking Phase 2 TDMA	P25 Standard
Features, Functions, and Services Support	Support CAI Features, Functions, and Services listed in Appendix E.	X	X	X	X
Phase 1 (FDMA) Common Air Interface	One channel bit-rate, modulation, and link layer are utilized for all voice and data capabilities, except for manufacturer-specific subsystems to provide backwards compatibility to existing manufacturer-specific systems.	X	X		X
Phase 2 (TDMA) Common Air Interface	One channel bit-rate, modulation, and link layer utilized for all voice and data capabilities, with backward compatibility to Phase 1 and analog.			X	X
Common Channel Operation	For common channel operation control, voice, and/or data, features shall be integrated into a single channel.	X	X	X	X

### 2.3.1. P25 Control Elements, Subscriber Management, and Call Processing Over the CAI

Common Air Interface	Description	Conventional Phase 1 FDMA	Trunking Phase 1 FDMA	Trunking Phase 2 TDMA	P25 Standard
Maintained Site Location of Subscriber Units	The site (or simulcast RF subsystem) location of all subscriber units, including authorized roamers, are maintained in a site location registry.	X	X	X	X
Mobility Tracking	This feature allows “tracking” of home users (SUs) when they roam to other RFSSs or when they return to their home system. The prior serving RFSS is updated when the user roams elsewhere.		X	X	
Registration and De-Registration	SUs are able to connect and disconnect themselves (i.e., “register”) to an RFSS.		X	X	X



Common Air Interface	Description	Conventional Phase 1 FDMA	Trunking Phase 1 FDMA	Trunking Phase 2 TDMA	P25 Standard
Talkgroup Affiliation	Allows the SU to affiliate with a talkgroup after unit registration is completed.		X	X	X
Location Registration	A registered and authorized SU that roams to access a new RF site in the same or different location registration area is capable of automatically requesting that the RFSS update its registration information to enable the RFSS to track the SU's current location (i.e., the current location registration area and the current RF site being accessed by the SU).		X	X	X
Confirmed	A confirmed call or data transfer attempts to secure RFSSs, sites, and users before starting the transmission.	X	X	X	X
Unconfirmed	An unconfirmed call or data transfer makes no particular effort to guarantee the participation of particular RFSSs, sites, or users.	X	X	X	X
Call Restriction	Ability to restrict some or all features available to an SU; this can be initiated by the system operator or pre-programmed into the SU.	X	X	X	X
Conventional Repeater Hangtime	A conventional repeater sends a specific data pattern during transmitter hangtime.	X			X
Operational Use of Conventional Talkgroups \$1000 and \$FFFF	Subscriber radios have a setting for the No Call talk group (\$1000) that inhibits receptions of all talkgroups except the All Call talkgroup (\$FFFF).	X			X
Surveillance Mode of Operations	Users have a mode of operation that can be used for surveillance activities. This includes the disabling of all visual and audio indicators.	X	X	X	
Busy Channel Lockout (Conventional Polite Mode)	The conventional SU is able to operate in a busy channel lockout mode, sensing whether the channel is busy before transmitting.	X			X

## 2.4. Inter-RF Subsystem Interface (ISSI)

### 2.4.1. General ISSI Needs

Inter-RF Subsystem Interface	Description	Conventional Phase 1 FDMA	Trunking Phase 1 FDMA	Trunking Phase 2 TDMA	P25 Standard
Features, Functions, and Services Support	Support ISSI Features, Functions, and Services listed in Appendix E.	X	X	X	X
P25 RFSS Connectivity	Any P25 RFSS that implements the ISSI is able to be connected through the ISSI to any other P25 RFSS that implements the ISSI, regardless of the types of P25 CAI(s). When connecting P25 RFSSs using the ISSI, the interconnected RFSSs may be in the same or different P25 WACNs or P25 systems. Each P25 RFSS is uniquely identifiable.		X	X	X
P25 RFSS and ISSI Function and Equipment Upgrade Capability <sup>1</sup>	P25 RFSS equipment from a manufacturer that offers the ISSI is upgradeable to provide the ISSI function and implement the associated ISSI equipment (hardware and software) without requiring major replacement of P25 RFSS equipment (hardware and software).		X	X	X
Roaming	The ISSI supports roaming of SUs among P25 RFSSs.		X	X	X
Operational Modes	The ISSI supports two or more RF subsystems operating in trunked mode, conventional mode, and mixed mode where any combination of them is operating elements of the RFSS in trunked mode and any other RFSS is operating elements in conventional mode.		X	X	X
Network Configurations	The ISSI supports both point-to-point (two RFSSs) and multipoint (more than two RFSSs) configurations using any of the operational modes listed above.		X	X	X
Bearer Media for Interconnection	Bearer services and/or teleservices provide interconnectivity between P25 RFSSs. The ISSI can operate, as required by system performance, over dedicated links: <ul style="list-style-type: none"> <li>T1, E1, Fractional T1 and Fractional E1 links and their aggregation into higher bandwidth links (e.g., SONET) IP-based networks (IPv4 and IPv6).</li> </ul>		X	X	X
Encryption Key Management	The ISSI allows transfer of P25-defined key management information across the ISSI.		X	X	X
Supported Services	The ISSI supports all services specified in the TIA P25 Systems and Standards Definition documents, and their future revisions.		X	X	X

<sup>1</sup> Manufacturers of P25 RFSS equipment (hardware and software) that is designed to support the ISSI function are expected to offer P25 RFSS equipment in a manner that will not require major replacement of P25 RFSS equipment to support addition of that manufacturer's ISSI equipment offerings. The ISSI function and equipment should be upgradeable through ISSI software revisions that enable maximum continued use of existing ISSI hardware. Manufacturers of P25 RFSS equipment that is not currently designed to support the ISSI function and equipment are expected to not require major replacement of that manufacturer's legacy P25 RFSS equipment if and when that manufacturer chooses to offer P25 RFSS equipment designed to support the ISSI function and equipment.

Inter-RF Subsystem Interface	Description	Conventional Phase 1 FDMA	Trunking Phase 1 FDMA	Trunking Phase 2 TDMA	P25 Standard
Control Element	The ISSI consists of a control element that conveys messages associated with the provision of services, including, but not limited to: <ul style="list-style-type: none"> <li>• Management and location tracking of subscribers</li> <li>• Authentication of subscribers</li> <li>• Management of the setup, maintenance, and tear down of a call, and</li> <li>• Providing over the air control and over the air rekeying of subscriber terminals.</li> </ul>		X	X	X
Traffic Element	The ISSI consists of a traffic element that conveys P25 voice and/or data traffic in both encrypted and clear formats between connected P25 RFSSs. Talkgroups to be scanned have selectable priority.		X	X	X

## 2.4.2. Subscriber Roaming Management (Unique to ISSI)

Inter-RF Subsystem Interface	Description	Conventional Phase 1 FDMA	Trunking Phase 1 FDMA	Trunking Phase 2 TDMA	P25 Standard
ISSI Roaming Management	The ISSI supports management of subscribers who roam onto ISSI-interconnected RFSSs.	X	X	X	X
SU Identification	The ISSI supports home validation of units that roam to a visited RFSS.	X	X	X	X
SU Validation	The validation of an SU roamer is accomplished via communication from the SU's home RFSS to the visited RFSS.	X	X	X	X
Resource Entitlement	Resource entitlement for the validated SU roamer is accomplished via communication from the SU's home RFSS to the visited RFSS (e.g., communication of resource entitlement for services and time limits).		X	X	X
Granting Requested Resources	The visited RFSS may grant the requested resources according to the SU's home resource entitlement, which may further be limited by the visited RFSS (i.e., according to the visited RFSS's resource availability or policy).	X	X	X	X
Temporary Duplicate "Home Data File"	Once a roamer has been validated and its resource entitlement conveyed to the visited RFSS, the visited RFSS shall maintain a temporary <sup>2</sup> duplicate "home data file" in order to provide a faster grade of service.	X	X	X	
Encryption Key Management	The ISSI allows transfer of P25-defined key management information across the ISSI.	X	X	X	X

2 "Temporary" refers to how long the data shall be maintained before it must be refreshed/updated, such as hours, days, etc. This directly impacts ISSI data link requirements.

Inter-RF Subsystem Interface	Description	Conventional Phase 1 FDMA	Trunking Phase 1 FDMA	Trunking Phase 2 TDMA	P25 Standard
Authorized Roamer Access in Emergency Mode	An authorized roaming subscriber is granted access to the visited RFSS and the ISSI whenever an emergency button is pressed on the SU. All ensuing emergency communications from the SU are also be sent to the home RFSS. An authorized roamer's emergency declaration and unit ID is recognized by the visited RFSS.	X	X	X	X
ISSI Support for Polling of RFSS Capabilities	Informs a system operator that the communication services for that operator's SUs are functioning properly on another RFSS.	X	X	X	X
In-Call Roaming	Roaming of individual call when one or both SUs move from one RFSS to another.	X	X	X	X
Adjacent Site Information	Display adjacent site control channels for use during automatic roaming.	X	X	X	

## 2.5. Fixed Station Interface

Fixed Station Interface	Description	Conventional Phase 1 FDMA	Trunking Phase 1 FDMA	Trunking Phase 2 TDMA	P25 Standard
Features, Functions, and Services Support	Support FSI Features, Functions, and Services listed in Appendix E.	X			X
Transport of Clear Audio	Transport of clear audio between a fixed station and its host, providing capabilities for full-duplex, half-duplex, and simplex communications at the discretion of the fixed station.	X			X
Transport of E&M Control Signaling	Transport of E&M control signaling between a fixed station and its host to provide a simple "push-to-talk" and "carrier on relay" capability. The intent of this requirement is that the FSSI support E&M interfaces used in legacy, pre-P25 analog fixed stations.	X			X
Tone Remote Control (TRC)	TRC controls signaling from a host to a fixed station to provide a variety of control functions. The intent of this requirement is that the CAFSI support TRC interfaces used in legacy, pre-P25 analog fixed stations. The TRC control shall include:  a) For airlinks supporting conventional FM operation: transmit channel control, squelch control, monitor control, and analog/digital mode control (if the fixed station also supports P25 digital (CAI) conventional operation); or  b) For airlinks supporting conventional P25 digital (CAI) operation: transmit channel control, squelch control, monitor control, clear/secure controls, and analog/digital mode control (if the fixed station also supports analog conventional operation).	X			X
Intercom Capability	Enables the transport of audio between the fixed station and its host without initiating an RF transmission.	X			X

Fixed Station Interface	Description	Conventional Phase 1 FDMA	Trunking Phase 1 FDMA	Trunking Phase 2 TDMA	P25 Standard
Airlinks Supported (FM Operation)	Conventional FM operation.	X			X
Airlinks Supported (P25 Digital (CAI) Operation)	Conventional P25 digital (CAI) operation.	X			X

## 2.5.1. Conventional Digital Fixed Station Interface (CDFSI)

Conventional Digital Fixed Station Interface	Description	Conventional Phase 1 FDMA	Trunking Phase 1 FDMA	Trunking Phase 2 TDMA	P25 Standard
IP-Based Capabilities	IP-based capabilities equivalent to those provided via the CAFSI when the digital fixed station is operating in analog mode.	X			X
Transport of Encrypted Audio	Transport of encrypted audio between a digital fixed station and its host.	X			X
Transport of Caller-ID Information	Transport of caller-ID information between a digital fixed station and its host. This includes unit ID from field units to consoles and from consoles to field units.	X			X
Transport of Talk-group Information	Transport of talk-group information between a digital fixed station and its host.	X			X
Transport of NAC Code Information	Reliable transport of NAC code information between a digital fixed station and its host, enabling a host console to select outgoing and display incoming Privacy Codes when the air interface is digital.	X			X
Transport of CTCSS/DCS Information	Reliable transport of CTCSS/DCS code information between a fixed station and its host, enabling a host console to select outgoing and display incoming Privacy Codes when the air interface is analog.	X			X
Transport of Emergency Alarm	Transport of Emergency Alarm and conventional control messages from the digital fixed station to its host.	X			X
Transport of Emergency Indications	Transport of Emergency Indications from the digital fixed station to its host.	X			X
Transport of Received Voter Identification	Transport of Received Voter Identification from the digital fixed station to its host.	X			X
Advanced Control of the Fixed Station – Frequency of Operation	The CDFSI enables remote control of a conventional fixed station’s operation for the frequency of operation.	X			X

Conventional Digital Fixed Station Interface	Description	Conventional Phase 1 FDMA	Trunking Phase 1 FDMA	Trunking Phase 2 TDMA	P25 Standard
Advanced Control of the Fixed Station – Repeating Voice	The CDFSI enables remote control of a conventional fixed station’s operation for repeating or not repeating in-bound voice on the outbound CAI.	X			X
Advanced Control of the Fixed Station – Receiver Squelch	The CDFSI enables remote control of a conventional fixed station’s operation for disabling or re-enabling the receiver squelch.	X			X
Intercom Audio	Transport intercom audio to and from the fixed station location.	X			X
Ethernet 100 Base-T	CDFSI equipment offers the option of Ethernet 100 Base-T with a RJ-45 connector as the physical and data link layers.	X			X
Other CDFSI Physical and Data Link Connectivity	In addition to Ethernet 100 Base-T, DFSI equipment may offer any industry standard physical and link layer protocols that support the internet protocol.	X			X

## 2.6. Non-P25 Interfaces

### 2.6.1. Network Management Interface

Network Management Interface	Description	Conventional Phase 1 FDMA	Trunking Phase 1 FDMA	Trunking Phase 2 TDMA	P25 Standard
Element Management	Manufacturer’s managed element offers corresponding network management capabilities as a standard option.	X	X	X	
Single Point of Entry	Management of P25 system components and software levels are able to be performed from a single point. This shall be accomplished in such a manner that an entry change to one database will automatically change all other associated databases without further user action.	X	X	X	
Assign Limited Set of Database Fields	As a standard option, the database administrator can assign a limited set of database fields for update by one or more specified database users.	X	X	X	
Multiple Databases	As a standard option, can update a limited subset of database fields.	X	X	X	
Vertical Partitioning	Overall system management is able to delegate vertical partitioning management to the organization responsible for the operation of the partition.	X	X	X	
Airlinks Supported (FM Operation)	Conventional FM operation.	X			X

Network Management Interface	Description	Conventional Phase 1 FDMA	Trunking Phase 1 FDMA	Trunking Phase 2 TDMA	P25 Standard
Airlinks Supported (P25 Digital (CAI) Operation)	Conventional P25 digital (CAI) operation.	X			X

## 2.6.2. Telephone Interconnect Interface

Telephone Interconnect Interface	Description	Conventional Phase 1 FDMA	Trunking Phase 1 FDMA	Trunking Phase 2 TDMA	P25 Standard
Full Duplex Telephone Interconnect	Develop a P25 Telephone Interconnect Interface (Et Interface) standard, which provides analog and digital interfaces between the P25 infrastructure (i.e., RFSS) and the PSTN enabling telephone interconnect of SUs and the PSTN.	X	X	X	
Full Duplex Telephone Interconnect	Full duplex telephone interconnect operation is supported between subscriber equipment and RFSSs.	X	X	X	
System Operator Control of PSTN Access	The system operator can selectively control SU access to/from the PSTN.	X	X	X	

## 2.6.3. Packet Data Host Network Interface

Packet Data Host Network Interface	Description	Conventional Phase 1 FDMA	Trunking Phase 1 FDMA	Trunking Phase 2 TDMA	P25 Standard
Fixed Host Data Interface Protocols	An RFSS supports a fixed-host data interface based on the internet protocol suite.	X	X	X	
Fixed Host to Mobile Data Terminal (MDT) Communication	The network enables a fixed host to identify and transparently communicate data with any MDT attached to an SU.	X	X	X	
Fixed Host to Fixed Host Communication	The P25 infrastructure enables a fixed host to communicate with any other fixed host attached to the P25 infrastructure (i.e., the fixed hosts may be attached via an Ed interface on the same or different RFSSs).	X	X	X	

---

## APPENDIX C

---

# List of User Needs for P25 Consoles

This section focuses on the user needs of telecommunicators and system administrators tasked with operating a console subsystem. These user needs address console interfaces and standards that enable console features and interoperability with subscriber equipment and other system components.



## 3.1. General Console Needs

P25 Consoles	Description	Conventional Phase 1 FDMA	Trunking Phase 1 FDMA	Trunking Phase 2 TDMA	P25 Standard
Console Patching	Allows dispatcher to connect voice channels in a wide range of configurations.	X	X	X	X
Dynamic Regrouping	Allows dispatcher to temporarily reassign selected radios to an ad-hoc group or channel without SU intervention.	X	X	X	X
Dispatcher Interrupt of Calls	A dispatcher has the ability to interrupt any call enabled by the system that an individual may be engaged in.	X	X	X	
Dispatcher Audio Takeover	The dispatcher, while monitoring a call, may interrupt the outbound audio of a transmitting radio and be heard by all units in the call, excluding non-full duplex transmitting radios but including the full duplex transmitting radios.	X	X	X	
Dispatcher Busy Call Takeover	When no channel is available (all traffic channels are in use) in an emergency situation, the dispatcher may override a channel, inclusive of the formerly transmitting unit. The pre-emption may be ruthless or “top-of-queue” as established by the system management function.	X	X	X	
Call Termination by a Dispatcher	Supplementary to group and individual calls, a dispatcher can terminate a call in progress. Upon invocation of this feature, the radio system tears down the selected call, freeing up pre-emptable system resources as soon as possible. In some circumstances, such as when a half duplex radio is the current talker in the group or individual call, the current site of the current talker may not be freed until the completion of the talker’s transmission. When the system has completed tearing down the call, normal operation of the group is resumed.	X	X	X	
Discreet Listening	The discreet listening feature allows an appropriately authorized system operator to listen to any active SU conversation, regardless of call type (e.g., individual call) and without the SU being aware of this activity. This differs from remote SU monitoring which provides the ability to key up remote SUs for monitoring (i.e., initiate a new call).	X	X	X	
Radio Unit Monitoring (Remote Unit Monitoring)	The system, if authorized, may enable a dispatcher to initiate a call which enables the dispatcher to listen to audio activity at a subscriber radio.	X	X	X	X
Dual-Tone Multifrequency (DTMF) Overdial	The system shall support digital DTMF overdial.	X	X	X	X
Transport of CTCSS/DCS Information	Reliable transport of CTCSS/DCS code information between a fixed station and its host, enabling a host console to select outgoing and display incoming Privacy Codes when the air interface is analog.	X			X
Transport of Emergency Alarm	Transport of Emergency Alarm and conventional control messages from the digital fixed station to its host.	X			X
Transport of Emergency Indications	Transport of Emergency Indications from the digital fixed station to its host.	X			X

P25 Consoles	Description	Conventional Phase 1 FDMA	Trunking Phase 1 FDMA	Trunking Phase 2 TDMA	P25 Standard
Transport of Received Voter Identification	Transport of Received Voter Identification from the digital fixed station to its host.	X			X
Advanced Control of the Fixed Station – Frequency of Operation	The CDFSI enables remote control of a conventional fixed station’s operation for the frequency of operation.	X			X
Advanced Control of the Fixed Station – Repeating Voice	The CDFSI enables remote control of a conventional fixed station’s operation for repeating or not repeating in-bound voice on the outbound CAI.	X			X

## 3.2. Console Subsystem Interface

Console Subsystem Interface	Description	Conventional Phase 1 FDMA	Trunking Phase 1 FDMA	Trunking Phase 2 TDMA	P25 Standard
Features, Functions, and Services Support	Support CSSI Features, Functions, and Services listed in Appendix E.		X	X	X
Packet Data	The CSSI supports the exchange of packet data between a console and (1) MDTs (including SUs that incorporate MDT functionality), (2) RFSSs (e.g., fixed station Hosts), and (3) other consoles.	X	X	X	X
Console Rekeying	The CSSI supports remote provisioning and management of security keys via a P25 KMF.	X	X	X	X
Telephone Patching	The CSSI supports telephone patching by the console.	X	X	X	X
Conventional/Trunking Patching	The CSSI supports patching between and among conventional and trunking resources. This means the CSSI supports patching of conventional resources to conventional resources, trunking resources to trunking resources, and conventional resources to trunking resources.	X	X	X	X
Time Synchronization	The CSSI supports the exchange of time synchronization data (where the time synchronization error does not exceed five seconds) between consoles, where the consoles may be exchanging information via different RFSSs, different P25 systems, or different P25 WACNs.		X	X	X
Voter Control and Status	The CSSI enables voter control by a console and reporting of voter status to a console for the conventional mode of operation.	X			X
Conventional Channel Status and Control	The CSSI supports the reporting of the status of conventional channels under the control of the console, as well as the control of the conventional channel itself.	X			X
Received NAC Code	The CSSI provides the NAC code associated with a received conventional call.	X			X
Transmit NAC Code	The CSSI supports the console’s ability to select the NAC for its voice transmissions.	X			X

Console Subsystem Interface	Description	Conventional Phase 1 FDMA	Trunking Phase 1 FDMA	Trunking Phase 2 TDMA	P25 Standard
Mode of Received Call	The CSSI provides the RF mode for received calls – digital or analog.	X			X
Conventional, Trunked, and Mixed Modes	The CSSI supports interoperability between multiple modes.	X	X	X	X
Detection and Reporting of Failure Conditions	The CSSI supports the exchange of information supporting detection and reporting of communication failures between a console and a RFSS, including the state of the CSSI to the rest of the system.	X	X	X	X
GPS/Automatic Vehicle Locator (AVL)	The CSSI supports the transport of GPS/AVL information.		X	X	X
Transport Layer	The CSSI supports unicast operation. The CSSI may support multicast operation.	X	X	X	X
Digital DTMF	The CSSI transports digital DTMF messages to and from the console subsystem. Digital DTMF refers to messages that indicate which DTMF digit was received or should be transmitted.	X	X	X	X

---

## APPENDIX D

---

# List of User Needs for P25 Subscriber Equipment

This section focuses on select user needs that enable subscriber interoperability between different manufacturers and/or impact life safety. As such, form factors, peripherals, and other unique subscriber implementations are out of scope.

## 4.1. Features, Functions, and Services Support

P25 Subscriber Equipment	Description	Conventional Phase 1 FDMA	Trunking Phase 1 FDMA	Trunking Phase 2 TDMA	P25 Standard
Voice Services	Support voice services in section 1.1.	X	X	X	X
Supplementary Data Services	Support supplementary data services in section 1.2.	X	X	X	X
Security Services	Support security services in section 1.3.	X	X	X	X
Location Services	Support location services in section 1.4.	X	X	X	X
Other Services	Support other services as needed or requested, described in section 1.5.	X	X	X	
Setup and Monitoring Functions	Support SU setup and tracking functions in section 1.6.	X	X	X	X

## 4.2. Mobile/Portable Subscriber Unit General Requirements

P25 Subscriber Equipment	Description	Conventional Phase 1 FDMA	Trunking Phase 1 FDMA	Trunking Phase 2 TDMA	P25 Standard
Analog Compliance	Meet the requirements specified in the current edition of TIA/EIA-603 "Land Mobile FM or PM Communications Equipment Measurement and Performance Standards."	X			X
Analog Support	Phase 1 subscribers receive a properly coded analog or digital signal on the same programmed channel without user intervention.	X	X		X
Electronic Serial Numbers (ESN)	An ESN is mandatory in a radio (subscriber unit). The validation response to an ESN inquiry is mandatory.	X	X	X	X
Military Specifications Methods	Mobile and portable equipment meet the applicable sections of MIL-STD-810E "Environmental Test Methods and Engineering Guidelines" as follows: <ul style="list-style-type: none"> <li>Method 506.3; Rain, Procedure I – Blowing Rain</li> <li>Method 509.3; Salt Fog, Procedure I – Aggravated Screening</li> <li>Method 510.3; Sand and Dust, Procedure I – Blowing Dust</li> <li>Method 514.4; Vibration, Procedure I, Category 10 – Minimum Integrity Test (3 Axis)</li> <li>Method 516.4; Shock, Procedure I – Functional Shock.</li> </ul>	X	X	X	
Support Conventional and Trunked Modes	The P25 subscriber is able to operate in a trunked and conventional mode, based on subscriber programming without the ability to have to be affiliated to a trunking system for conventional operation.	X	X	X	X

P25 Subscriber Equipment	Description	Conventional Phase 1 FDMA	Trunking Phase 1 FDMA	Trunking Phase 2 TDMA	P25 Standard
Phase 2 Subscriber Equipment in a Trunked Phase 1 System	Phase 2 subscriber units intended to replace trunked Phase 1 equipment are able to operate in both trunked Phase 1 and Phase 2 modes on a functional channel basis.			X	X
Channel Width	Channel utilization of 12.5 kHz in Phase 1 and 6.25 kHz equivalency in Phase 2.	X	X	X	X
Efficient Use of RF Resources	Calls do not require resources at sites that do not contain addressed subscriber units (except simulcast RF subsystems).	X	X	X	X
Channel Scan	Mobile and portable equipment, both trunking and conventional, are able to sequentially scan both conventional channels (at least 8) and a trunked system's control channel in both clear and encrypted mode. While on the trunked system's control channel, the mobile and portable equipment can sequentially scan trunked talkgroups (at least 8) in both clear and encrypted mode. All scans are completed in minimum time. The conventional and/or trunked talkgroups to be scanned have selectable priority.	X	X	X	X
Connection to an External Audio and Push-to-Talk System	Mobile radio equipment includes an interface to allow connection of an external audio and push-to-talk system. Audio appearing at this interface is unencrypted.	X	X	X	
Data Port for MDT, Portable Computer, or Other Peripheral Device	Support a data port to an attached MDT, portable computer, or other peripheral device. The data port enables text messaging between units. Text messages may be up to 256 characters in length and be sent via SU keyboard entry or from a data terminal device connected to a SU, exclusive of overhead.	X	X	X	X
Data Port to Peripherals	Support a multi-point data port to multiple external peripherals.	X	X	X	X
Minimum Keypad Configuration	Adopt a 4-row by 3-column matrix as the minimum key pad configuration with the first level and shifted functions software programmable and assignable. Label Configuration to conform to the North American telephone keypad standard numerical and symbol layout.	X	X	X	
Digitally Store Functional Characteristics	A P25 radio is capable of digitally storing functional characteristics, including, but not limited to, channel frequencies, minimum volume settings, and channel scanning patterns. The stored functional characteristics are issued from an authorized field-programming device.	X	X	X	
Duplex Individual Calls	Duplex call is available only to individual calls. This feature enables a properly equipped SU to listen to inbound audio while transmitting outbound audio.	X	X	X	X
DTMF Signaling	The subscriber units are capable of generating digital DTMF signals from the keypad.	X	X	X	

## 4.3. Vehicular Repeater (VR) Capability

P25 Subscriber Equipment	Description	Conventional Phase 1 FDMA	Trunking Phase 1 FDMA	Trunking Phase 2 TDMA	P25 Standard
Full Duplex	The vehicular repeater link channel provides two-way, full duplex operation to permit system control and handshake and to permit multiple associated subscriber units to operate on the same single link channel. An FDMA or two-slot TDMA vehicular repeater link requires two frequencies, one for each direction of communication.	X	X	X	X
Direct Mode	Unit-to-unit operation (simplex operation).	X	X	X	X
Unit to Unit Directed and Repeated	Directed unit-to-unit operation and repeated auto selection based on Private Line/Digital Private Line/NAC.	X	X	X	X
In-Band Operation	Repeater link channel operation is in the same frequency band as the infrastructure channels, so subscriber units can be used either direct to the infrastructure or through the vehicular repeater. A single antenna and a duplexer that incorporates appropriate filtering is desired for the vehicular repeater control link, with a separate antenna for the system mobile.	X	X	X	X
Manual or Auto Channel Selection	Where a vehicular repeater system has multiple link channels available, the link channel to be used by a particular repeater may be selected manually or automatically. Means shall be provided to “mark” an active repeater link channel as “in-use” on a first come, first served basis, so that other repeater units, within radio signal range, will not select that same channel.		X	X	X
Extended Range	The vehicular repeater unit provides for a subscriber unit (typically a portable handheld unit) to operate with full feature capability in order to achieve extended signal coverage from/to the infrastructure or from/to other subscriber units. It is possible to repeat scanned channels of the system mobile receiver subject to personality programming (the programming required to allow the subscriber to operate on a specific trunking system such as trunking ID, system key, and talkgroups).	X	X	X	
In-Vehicle or Stand-Alone	The vehicular repeater unit may be a vehicle-mounted mobile system or a totally self-contained portable system. As a vehicle-mounted mobile system, it is an integrated vehicular repeater/mobile radio package.	X	X	X	
Operational Control	The vehicular repeater unit is controlled by appropriate control words transmitted by the controlling subscriber unit. Such control words may include Network Access Codes, and source and destination IDs. System control functions may be operated manually from within the vehicle.	X	X	X	X
One-to-One Operation	A single subscriber unit is able to operate exclusively through its companion vehicular repeater unit (“repeat unit”) and be able to remotely control the mobile operating channel in a conventional infrastructure, or the mobile system and talkgroup in a trunking infrastructure. Within the limitations of system implementation, all other subscriber unit functions operate transparently through the vehicular repeater system. Control functions are communicated over the link channel using digital signaling with handshaking for a positive acknowledgement.	X	X	X	

P25 Subscriber Equipment	Description	Conventional Phase 1 FDMA	Trunking Phase 1 FDMA	Trunking Phase 2 TDMA	P25 Standard
More Than One Operation	One or more portable radio units are able to operate through a single vehicular repeater unit. Subscriber unit access may be permitted by the use of Network Access Codes, including the receiver NAC \$F7F for multiple subscribers from different groups. Additional subscriber units arriving within range of this single vehicular repeater can manually select the “in-use” link channel for this repeater (“repeat group”).	X	X	X	
Any Emergency In One-To-One Operation	Ability to pair a vehicular repeater unit with its associated subscriber unit such that only control commands and functions from that subscriber unit are recognized by the associated vehicular repeater control system, except that any unit operating through this vehicular repeater in “repeat group” mode may transmit an emergency status. It is possible to pair a subscriber unit and a vehicular repeater in the field without special programming equipment. The command set for this option includes the capability for the controlling subscriber unit to place the vehicular repeater unit into the “repeat unit” or “repeat group” modes.	X	X	X	
Vehicle Repeater Activation	Activation of vehicular repeater mode operation are provided by both front panel control and by remote activation (e.g., seat switch, vehicular charger socket insertion switch). Remote activation is accomplished by contact closure, voltage sensing, or current sensing, and shall be isolated from vehicle power and ground to permit implementation flexibility.	X	X	X	
Single Control Capability	Vehicle control systems use a single control head, loudspeaker, and microphone for all functions of the vehicular repeater/mobile radio system when they are an integrated unit.	X	X	X	
Ease of Operation	Control systems of portable and vehicular equipment provide simple, easy to understand, and easy to operate functions.	X	X	X	
Full Control or Covert Installation	A full-function control and display is offered in a remote speaker/microphone assembly that can be used with mobile units where a concealed installation is required.	X	X	X	



## 4.4. Mobile Data Peripheral Interface

Mobile Data Peripheral Interface	Description	Conventional Phase 1 FDMA	Trunking Phase 1 FDMA	Trunking Phase 2 TDMA	P25 Standard
Mobile Data Interface Protocols	The A Interface between a SU and one or more MDTs are compatible with IP (IPv4 and IPv6) standards.	X	X	X	
MDT to MDT Communication	The P25 system provides for any MDT attached to a SU to communicate with any other MDT attached to a SU (direct mode, repeat mode, network mode).	X	X	X	
MDT to Fixed Host Communication	The system provides the ability for any MDT attached to a SU to communicate with any fixed host attached to the network.	X	X	X	
Minimum Data Speed	Data transmission operates at a speed of at least 9,600 bps (including overhead) over the air.	X	X	X	

---

## APPENDIX E

---

# Features and Functions Applicable to Each Interface

## 5.1. Modes

	P25 Interface					
Features and Functions	FDMA CAI	TDMA CAI	ISSI	CSSI	AFSI	DFSI
Conventional	X		X	X	X	X
Trunking	X	X	X	X		

## 5.2. Voice Services (Section 1.1.)

	P25 Interface					
Features and Functions	FDMA CAI	TDMA CAI	ISSI	CSSI	AFSI	DFSI
Group Call	X	X	X	X	X	X
Individual Call	X	X	X	X	X	X
Announcement Group Call	X	X	X	X		
Broadcast Call	X	X	X	X		
Emergency Call	X	X	X	X	X	X
System-Wide Group Call (System Call)	X	X			X	X
Priority Call	X	X	X	X		
Preemptive Priority Call	X	X	X	X		
PSTN Interconnect Call	X	X	X	X		

## 5.3. Supplementary Data Services (Section 1.2.)

	P25 Interface					
Features and Functions	FDMA CAI	TDMA CAI	ISSI	CSSI	AFSI	DFSI
Transport of Talker ID	X	X	X	X	X	X
Emergency Alarm (Alert)	X	X	X	X	X	X
Emergency Alarm Cancel	X	X	X			
Group Emergency Cancel	X	X	X			
Call Alert	X	X	X	X	X	X
Short Message	X	X	X	X	X	X
Status Query	X	X	X	X	X	X
Status Update	X	X	X	X	X	X
Radio Unit Monitoring	X	X	X	X	X	X
Radio Check	X	X	X	X	X	X

	P25 Interface					
Features and Functions	FDMA CAI	TDMA CAI	ISSI	CSSI	AFSI	DFSI
Radio Detach	X	X	X	X	X	X
Radio De-Authorization	X	X	X			
Radio Inhibit	X	X	X	X	X	X
Radio Un-inhibit	X	X	X	X	X	X

## 5.4. Location Services (Section 1.3.)

	P25 Interface					
Features and Functions	FDMA CAI	TDMA CAI	ISSI	CSSI	AFSI	DFSI
Tier 1 Location Services	X	X	X	X		
Tier 2 Location Services	X	X	X	X		

## 5.5. Security Services (Section 1.4.)

	P25 Interface					
Features and Functions	FDMA CAI	TDMA CAI	ISSI	CSSI	AFSI	DFSI
Encrypted Call	X	X	X	X	X	X
Authentication	X	X	X		X	X
Over-the-Air Rekeying	X	X				
Encryption Key Update			X	X		
Link Layer Encryption	X	X				

## 5.6. Other Services (Section 1.5.)

	P25 Interface					
Features and Functions	FDMA CAI	TDMA CAI	ISSI	CSSI	AFSI	DFSI
Over-the-Air Programming	X	X				
Text Messaging	X	X	X	X	X	X
Interconnection with Non-P25 Systems			X	X	X	X
Manual Roaming	X	X	X	X	X	X
Automatic Roaming	X	X	X			
Audible Signaling					X	X

	P25 Interface					
Features and Functions	FDMA CAI	TDMA CAI	ISSI	CSSI	AFSI	DFSI
Subaudible Signaling (squelch and tone controls)					X	X
Individual Regrouping	X	X	X	X		
Group Regrouping	X	X	X	X		



**NOTE:**

Manufacturer-specific manuals and training materials were not used in the creation of the SPUN. However, they are often the best source of technical information on specific P25 system components, equipment, and design configurations.

---

**APPENDIX F**

---

# **Additional Resources**

Many resources were used to create this document and can be used to learn more about P25. Some of those resources are listed below.

## The Project 25 Technology Interest Group (PTIG) Website

PTIG promotes the success of Project 25 and educates interested parties on the benefits the standard offers. The [PTIG website](#) features detailed information on Project 25, including white papers, standards documents, conference presentations, and case studies. Documents used to inform the SPUN include:

### “PTIG – Is P25 Public Safety Grade?”

This white paper explains the different levels of compliance statements that may be a) used by customers or consultants when specifying an equipment purchase or b) used by manufacturers promoting equipment capabilities.

<http://www.project25.org/index.php/documents/p25-whitepapers>

### “PTIG – Capabilities Guide, v1.7”

A guide that lists the capabilities of subscriber and infrastructure equipment enabled by the TIA-102 series of published standards.

[http://www.project25.org/images/stories/ptig/docs/PTIG\\_P25Capabilities\\_Guide\\_v1.7.pdf](http://www.project25.org/images/stories/ptig/docs/PTIG_P25Capabilities_Guide_v1.7.pdf)

## P25 Statement of Requirements, 2013

The Project 25 Statement of Requirements (P25 SoR) is the basis for the suite of standards published by TIA and adopted as Project 25 Standards. Project 25 represents a standards profile for satisfying the service, feature, and capability requirements users have for their digital narrowband private land mobile radio systems. The SoR describes those requirements for public safety critical communications.

<http://www.project25.org/index.php/documents/suggested/241-p25-sor-published-q4-2013>

## TIA Website, P25 Standards Suite

Engineering Committee TR-8 formulates and maintains standards for private radio communications systems and equipment for both voice and data applications. TR-8 addresses all technical matters for systems and services, including terminology, definitions, and interoperability, compatibility, and compliance requirements for business and industrial applications, as well as public safety (e.g., law enforcement, fire service, and emergency medical services) applications.

Much of the work of the committee relates to the formulation of TIA-102 Series standards for Association of Public-Safety Communications Officials (APCO) Project 25. These standards are sponsored by the APCO, NASTD and agencies of the federal government. Project 25 standards provide digital voice and data communications systems suited for public safety and first-responder applications.

[http://standards.tiaonline.org/standards/technology/project\\_25/index.cfm](http://standards.tiaonline.org/standards/technology/project_25/index.cfm)

<http://standards.tiaonline.org/standards/committees/committee.cfm?comm=tr-8>

## Codan – P25 Radio Systems Training Guide, 2013

Document written by Codan Communications (formerly Daniel Electronics) to give readers a simple, concise description of Project 25. The document assumes the reader is familiar with conventional Two-Way Radio Communications systems.

[https://cdn.codancomms.com/general-downloads/Products/User-Guides/Codan\\_TG-001-4-0-0-P25-Training-Guide.pdf?mtime=20190116102143](https://cdn.codancomms.com/general-downloads/Products/User-Guides/Codan_TG-001-4-0-0-P25-Training-Guide.pdf?mtime=20190116102143)

## Tait Best Practices Website and Videos

Series of P25 documents and videos developed by Tait Communications for public safety officials responsible for, or otherwise involved in, procuring new communication systems.

<https://www.p25bestpractice.com/>

<https://www.taitradioacademy.com/>

## Public Safety Wireless Network (PSWN) – Comparisons of Conventional and Trunked Systems, 1999

This is an older document; however, it still provides relevant analysis of conventional, trunked, and hybrid system architectures to provide background information to public safety system planners on the different architecture alternatives.

<https://www.hSDL.org/?view&did=462329>



# SAFECOM and the National Council of Statewide Interoperability Coordinators Website

**SAFECOM** was formed in 2001 after the terrorist attacks of September 11, 2001, as part of the Presidential E-Government Initiative to improve the interoperability of public safety communications. Its programs aim at enabling emergency responders to communicate effectively before, during, and after emergencies and disasters. SAFECOM's mission is to improve designated emergency responders' inter-jurisdictional and inter-disciplinary emergency communications interoperability through collaboration across federal, state, local, tribal, and territorial governments, and international borders.

Established by the Cybersecurity and Infrastructure Security Agency (CISA) in July 2010, the National Council of Statewide Interoperability Coordinators supports Statewide Interoperability Coordinators (NCSWIC) from the 56 states and territories, by developing products and services to help them leverage their relationships, professional knowledge, and experience.

<https://www.cisa.gov/safecom> and <https://www.cisa.gov/ncswic>

## P25 Compliance Assessment Program

P25 Compliance Assessment Program (CAP), a voluntary program, allows suppliers to publicly attest to their products' compliance through P25 CAP testing at Department of Homeland Security-recognized laboratories. (More information on page 52.)

<https://www.dhs.gov/science-and-technology/p25-cap>

### MANUFACTURER-PROVIDED TECHNICAL/USER MANUALS

#### NOTE:

While the SPUN did not draw on manufacturer-specific technical manuals, those materials are often the best source of technical information on specific P25 system components and equipment.

---

**APPENDIX G**

---

# **Acronyms**

<b>ACRONYM</b>	<b>DEFINITION</b>
AES	Advanced Encryption Standard
AFSI	Analog Fixed Station Interface
AMBE	Advanced Multi-Band Excitation
ANSI	American National Standards Institute
APCO	Association of Public-Safety Communications Officials
APIC	APCO Project 25 Interface Committee
AVL	Automatic Vehicle Locator
BPS	Bits Per Second
CAD	Computer Aided/Assisted Dispatch
CAFSI	Conventional Analog Fixed Station Interface
CAI	Common Air Interface
CAP	Compliance Assessment Program
CC	Control Channel
CDFSI	Conventional Digital Fixed Station Interface
CISA	Cybersecurity and Infrastructure Security Agency
CSSI	Console Subsystem Interface
CTCSS	Continuous Tone-Coded Squelch System
DCS	Digital Code Squelch
DES	Data Encryption Standard
DFSI	Digital Fixed Station Interface
DHS	Department of Homeland Security
DTMF	Dual-Tone Multi-Frequency
DVRS	Digital Vehicular Repeater Systems
E&M	Ear and Mouth
ECC	Emergency Communications Center
EIA	Electronic Industries Alliance
ESN	Electronic Serial Numbers
FCC	Federal Communications Commission
FDMA	Frequency Division Multiple Access
FNE	Fixed Network Equipment
FSI or FSSI	Fixed Station Interface
GPS	Global Positioning System
IKI	Inter-KMF-Interface
IMBE	Improved Multi-Band Excitation
IPv4	Internet Protocol Version 4
ISSI	Inter-RF Subsystem Interface
KFD	Key Fill Device
KFI	Key Fill Interface

<b>ACRONYM</b>	<b>DEFINITION</b>
kHz	Kilohertz
KMF	Key Management Facility
LLE	Link Layer Encryption
LMR	Land Mobile Radio
LSHS	Location Service Host System
LTE	Long-Term Evolution
MDPI	Mobile Data Peripheral Interface
MDT	Mobile Data Terminal
MHz	Megahertz
NAC	Network Access Code
NASTD	National Association of State Technology Directors
NMI	Network Management Interface
NTIA	National Telecommunications and Information Administration
OTAP	Over-the-Air Programming
OTAR	Over-the-Air Rekeying
P25	Project 25
PDHNI	Packet Data Host Network Interface
PDU	Packet Data Units
PSAP	Public Safety Answering Point
PSTN	Public Switched Telephone Network
PTIG	P25 Technology Interest Group
RF	Radio Frequency
RFSS	Radio Frequency Subsystem
SDO	Standards Development Organization
SOR	Statement of Requirements
SPUN	Statement of Project 25 User Needs
SU	Subscriber Unit
SUID	Subscriber Unit ID
TC	Traffic Channel
TDMA	Time Division Multiple Access
TIA	Telecommunications Industry Association
TII	Telephone Interconnect Interface
TRC	Tone Remote Control
UHF	Ultra High Frequency
VHF	Very High Frequency
WACN	Wide Area Communications Network
WUID	Working Unit ID